

CONTENTS

| | | |
|------------|----------------------------------------------------------------------|------------------------------------------------------------------------------------------|
| SR1 | SPORTING REGULATIONS | 2 |
| SR1.1 | Titles & Jurisdictions | 2 |
| SR1.2 | Officials | 2 |
| SR1.3 | Competitor Eligibility | 2 |
| SR1.4 | Registration | 3 |
| SR1.5 | Championship Events | 3 |
| SR1.6 | Scoring | 3 |
| SR1.7 | Awards | 4 |
| SR1.8 | Mini Libre Invitation (Sporting Guidelines – 2023) | 6 |
| SR1.9 | Mini-7 S-Class | 6 |
| SR2 | CHAMPIONSHIP EVENT MEETINGS & RACE PROCEDURES | 7 |
| SR2.1 | Entries | 7 |
| SR2.2 | Briefings | 7 |
| SR2.3 | Qualification Practice | 7 |
| SR2.4 | Races | 8 |
| SR2.5 | Starts | 8 |
| SR2.6 | Session Red Flag | 9 |
| SR2.7 | Pits, Paddock & Pitlane Safety | 9 |
| SR2.8 | Race Finishes | 9 |
| SR2.9 | Results | 9 |
| SR2.10 | Timing Modules | 9 |
| SR2.11 | Qualification Races | 9 |
| SR2.12 | Operation of Safety Car | 10 |
| SR2.13 | Onboard Cameras | 10 |
| SR2.14 | Radio Equipment | 10 |
| SR2.15 | Re-Scrutineering | 10 |
| SR3 | SPECIFIC CHAMPIONSHIP REGULATIONS | 11 |
| SR3.1 | Judicial Procedures | 11 |
| SR3.2 | Technical Disputes | 11 |
| SR3.3 | Clarifications / Rulings on Technical Regulations | 11 |
| SR4 | SPECIFIC CHAMPIONSHIP PENALTIES | 12 |
| SR4.1 | Infringements of Technical Regulations | 12 |
| SR4.2 | Additional Specific Championship Penalties | 12 |
| TR5 | TECHNICAL REGULATIONS – GENERAL (Se7en, S-Class & Miglia) | 13 |
| TR5.1 | Introduction | 13 |
| TR5.2 | General Description | 13 |
| TR5.3 | Safety Requirements | 13 |
| TR5.4 | General Technical Requirements & Exceptions | 14 |
| TR5.5 | Chassis | 14 |
| TR5.6 | Bodywork | 14 |
| TR5.7 | Engine | 16 |
| TR5.8 | Suspension | 17 |
| TR5.9 | Transmission | 17 |
| TR5.10 | Electrics | 17 |
| TR5.11 | Brakes | 17 |
| TR5.12 | Wheels / Steering | 18 |
| TR5.13 | Tyres | 18 |
| TR5.14 | Weights | 18 |
| TR5.15 | Fuel Tank / Fuel | 18 |
| TR5.16 | Silencing | 19 |
| TR5.17 | Numbers & Championship Decals | 19 |
| TR5.18 | Specific Technical Regulations – Mini Se7en | 20 |
| TR5.19 | Specific Technical Regulations – Mini-7 S-Class | 23 |
| TR5.20 | Specific Technical Regulations – Mini Miglia | 27 |
| TR5.21 | Specific Technical Guidelines – Mini Libre Invitation | 30 |
| SR6 | APPENDICES | 32 |
| SR6.1 | Race Organising Clubs & Contacts | 32 |
| SR6.2 | Commercial Undertakings | 33 |
| SR6.3 | Trade Support Vehicle Decals & Overall Patches | 34 |
| SR6.4 | Promotional Activities | 34 |
| SR6.5 | Mini Seven Racing Club Champions | 35 |
| SR6.6 | Sealing Images / Reference | 38 |
| SR6.7 | Appendix 1 – Motorsport UK Race With Respect | 39 |
| SR7 | REGISTRATION FORM | See separate sheet or online @ www.m7rc.co.uk |

SR.1 SPORTING REGULATIONS – GENERAL

SR.1.1 TITLES & JURISDICTIONS:

SR.1.1.1 (a) The 2023 Dunlop Mini Challenge supported by Mini Spares will be organised and administered by the Mini Seven Racing Club (M7RC), in accordance with the General Regulations of Motorsport UK (incorporating the provisions of the International Sporting Code of the FIA) and these Championship Regulations.

Motorsport UK Championship Permit No: CH2023 / R111 (C) Race Status: Club Grade: C

SR.1.1.1 (b) The 2023 '0-Plate' Winter Mini Challenge will be organised and administered by the Mini Seven Racing Club (M7RC), in accordance with the General Regulations of the Motorsport UK (incorporating the provisions of the International Sporting Code of the FIA) and these Championship Regulations.

Motorsport UK Championship Permit No: CH2023 / R112 (C) Race Status: Club Grade: C

SR.1.1.2 The Challenge Organisers reserve the right to issue additional Official Bulletins clarifying items in the Regulations from time to time and all such Official Bulletins (including championship tables etc.) will be published on the official M7RC website (www.mini7.co.uk). Notification will be sent via e-mail to each competitor at the e-mail address detailed on the registration form. The competitor will not receive notification if an e-mail address is not provided, or is incorrect and/or does not work.

SR.1.1.3 The Challenge Organisers reserve the right to carry out necessary or required changes to these Regulations which are due to *force majeure*, or for safety reasons, or if requested by the authorities by means of Official Bulletins. Refer also to section 5 of **M7RC By-Laws**.
The Challenge Organisers further reserve the right to cancel events if necessary due to exceptional unforeseeable conditions, and are not liable for any damages so incurred as a result.
(See **current Motorsport UK Yearbook D11.1**)

SR.1.1.4 Exclusion from Liability. (See **current Motorsport UK Yearbook D13.1**)

SR.1.2 OFFICIALS:

SR.1.2.1 Championship Co-ordinator for the Challenges is Richard Williamson, assisted by Barry Payne and/or Naomi Healey and/or other M7RC-nominated persons for Co-ordinator's race meeting duties.

SR.1.2.2 Licensed Eligibility Scrutineer is Julian Affleck, who will enforce the Technical Regulations, and who will consult with Roger Ratley (Motorsport UK Technical Commissioner) when required. A replacement Scrutineer/s may be co-opted to cover *force majeure* situations. A M7RC technical advisor and/or Technical Sub-Committee may also offer advice/assistance to the Licensed Eligibility Scrutineer as and when required.

SR.1.2.3 Championship Stewards will comprise a panel of three, from David Scott, Ian Watson, Trevor Parry and Steve Burns. Replacement Stewards may be co-opted to cover *force majeure* situations and in this case a championship bulletin will be issued.

Championship Stewards:

G2.7 (in current Motorsport UK Yearbook) Championship Stewards may only adjudicate on any disputes, irregularities or appeals arising from the approved Championship regulations.

G2.7.1 Championship Stewards are also empowered to consider any request from the Championship Co-ordinator to penalise any Competitor for any breach of Championship regulations after holding a formal hearing to impose a penalty in accordance with **C2.1.1** (subject to the rights of appeal provided for in **Section C, Judicial**).

W2.2.1 (in current Motorsport UK Yearbook). The Championship Stewards can only adjudicate upon any disputes, irregularities or appeals arising from the approved Championship Regulations. They are also empowered to consider any request from the Championship Co-ordinator to penalise any Competitor for breach of Championship Regulations and, after holding a formal hearing, to impose a penalty in accordance with **C2.1**, (subject to the rights of appeal to the MSC provided in **Section C, Judicial**).

SR.1.2.4 Clerk of the Course for the M7RC is Luke Caudle.
A replacement Clerk of the Course may also be co-opted to cover *force majeure* situations.

SR.1.3 COMPETITOR ELIGIBILITY:

SR.1.3.1 Entrants must:

- be fully paid-up valid membership card-holding Members of the M7RC and
- be Registered for the Challenge and
- be in possession of a valid Motorsport UK Entrants' Licences.

SR.1.3.2 Drivers and Entrant/Drivers must:

- be current Members of the M7RC and
- be Registered for the Challenge and
- be in possession of a valid Competition (Racing) Club status Licence, as a minimum;
- or be in possession of the highest grade of National Race licence or valid FIA International Licence, together with their ASN's written consent [**current Motorsport UK H25.2 & FIA ISC Article 2.3.7.b** applies)

- e) If participation in the Challenge requires absence from education, a driver in full-time education is required to have the approval of their head teacher and a letter stating such approval from their school in order to fulfil registration for the Challenge. A driver shall not take time out of their education to participate in motorsport without the prior written approval of their education department.

SR.1.3.3 All necessary documentation must be presented for checking at all rounds when signing-on.

SR.1.4 REGISTRATION:

SR.1.4.1 All Competitors must register for the Challenge by returning the Registration Form, with the Registration Fee (including any agreed part-season fee), to the M7RC prior to the Final Closing date for the first round (or subsequent round/s) being entered. The fee includes M7RC membership, and acceptance of registration is entirely at the discretion of the Challenge Organisers/Promoters.

SR.1.4.2 The full-season Registration Fee is £225 - Made payable to: The Mini Seven Racing Club (M7RC). Part-season registration fees will only be considered from after mid-point of the Challenge season, and will be notified to the competitor on application. Note - 50% reduction on all membership fees for applicants aged 21 and under.

SR.1.4.3 Registration numbers will be the permanent Competition numbers for the Challenge.
Only one Driver may be nominated per Registration Form.
In cases of number clashes with combined-class grids, temporary alternative Competition numbers will be issued by the Championship Coordinator or Membership Secretary.

SR.1.4.4 No Organising Club will accept race entries unless the Competitor has registered and been issued a permanent Competition racing number.

SR.1.5 CHAMPIONSHIP EVENTS:

The 2023 Dunlop Mini Challenge supported by Mini Spares will be contested over 17 Rounds for each formula (Mini Se7en, Mini-7 S-Class and Mini Miglia) as follows:

| <i>Round:</i> | <i>Date:</i> | <i>Circuit:</i> | <i>Organising Club:</i> | <i>Grids:</i> |
|---------------|--------------|---------------------|-------------------------|---------------|
| 1 + 2 | 18-19 March | Silverstone GP | BRSCC | Combined |
| 3 + 4 | 15-16 April | Donington Park Nat. | MSVR | Single |
| 5 + 6 | 13-14 May | Snetterton 300 | BARC | Single |
| 7 + 8 | 3-4 June | Thruxton | BARC | Single |
| 9 + 10 + 11 | 14-16 July | Zandvoort GP | CP.com | Combined |
| 12 + 13 | 5-6 August | Brands Hatch Indy | MSVR | Single |
| 14 + 15 | 16-17 Sept' | Croft | BRSCC | Single |
| 16 + 17 | 7-8 October | Silverstone Int. | BRSCC | Single |

The 2023 '0-Plate' Winter Mini Challenge will be contested over 7 Rounds for each formula as follows:

| <i>Round:</i> | <i>Date:</i> | <i>Circuit:</i> | <i>Organising Club:</i> | <i>Grids:</i> |
|---------------|---------------|-------------------|-------------------------|---------------|
| 1 + 2 | 18-19 March | Silverstone GP | BRSCC | Combined |
| 3 + 4 | 7-8 October | Silverstone Int. | BRSCC | Single |
| 5 + 6 + 7 | 21-22 October | Brands Hatch Indy | BRSCC | Combined |

All rounds are for Drivers' Championships.

SR.1.5.1 Mini Libre competitors will race alongside the Mini Miglia Challenge, on an Invitation basis (see SR.1.6.5 & SR.1.8).

SR.1.6 SCORING:

SR.1.6.1 Points will be awarded to Competitors listed as classified finishers in the Final Results as follows:

| | | | | | |
|------|---|-----------|---------------------|---|-----------|
| 1st | - | 20 points | 11th | - | 10 points |
| 2nd | - | 19 points | 12th | - | 9 points |
| 3rd | - | 18 points | 13th | - | 8 points |
| 4th | - | 17 points | 14th | - | 7 points |
| 5th | - | 16 points | 15th | - | 6 points |
| 6th | - | 15 points | 16th | - | 5 points |
| 7th | - | 14 points | 17th | - | 4 points |
| 8th | - | 13 points | 18th | - | 3 points |
| 9th | - | 12 points | All other finishers | - | 2 points |
| 10th | - | 11 points | All non-finishers | - | 1 point |
| | | | Fastest Lap | - | 1 point |

If a dead heat is declared, all Drivers concerned will score full points for that position. At a meeting where there are Heats and a Final for either formula, points will be awarded for the final down to 18th position only. Finishers and non-finishers points for all other Competitors will be given on Heat results. Should a Consolation or Qualifying race be run for a Challenge round, Competitors will score 2 points for a finish or 1 point for a non-finish. These points will not be in addition to any earned in the main race.
Eligible drivers competing under the S-Class regulations will score points as above.

Mini-7 S-Class will form up on the grid behind the main Mini Se7en Challenge.
For double- and treble-race meetings, SR.2.3.3 will apply. Refer also to sections SR.2.3 and SR.2.5.

A change of eligible car during the Challenges will not affect a Driver's points total.

In order to score points, collect trophies and awards, all cars and Drivers competing in the Challenges will be required to display and wear the Challenge Sponsors' decals and badges in the nominated positions.
(See TR.5.17).

SR.1.6.2 The totals from all Challenge Races run, less 3 in the main Challenge and less 2 in the Winter Challenge, will determine final championship points and positions (note the requirements of SR.4). A race will be considered to be run when a race classification is produced by the timekeepers (eg. TSL).

SR.1.6.3 Ties shall be resolved using the formula in **W1.3.4 (in current Motorsport UK Yearbook)**:

- by considering the best scoring events of the Competitors concerned, the number of first places or class wins;
- by considering the number of class or outright second places where there are no classes, and so on in the best scoring events;
- by considering the placings in all Challenge events;

In addition:

- by taking into account the value of any discarded (dropped) points at season end;
- by taking into account the number of Competitors (i.e. race finishers) beaten during the season.

SR.1.6.4 Where the race distance has been reduced (SR.2.6) it shall still count as a full points-scoring round, including abandoned races which fail to reach a result after a qualifying grid has been established (i.e. a 0 score). Abandoned rounds may be re-run at an alternative race meeting before the end of the current season **Q7.11 & Q7.11.1 (in current Motorsport UK Yearbook)**.

SR.1.6.5 Competitors not registered for the Challenges may be invited by the M7RC on an individual round basis and will:

- be deemed 'Guest Competitors', including Mini Libre / Development / Celebrity cars;
- not score Challenge points;
- qualify for Event awards;
- comply with the eligibility criteria as prescribed in SR.1.3 with the exception of SR.1.3.1 (b) and SR.1.3.2 (b), as appropriate.

SR.1.7 AWARDS:

SR.1.7.1 All awards are to be provided by the M7RC and its associated Sponsors (except where Race Organisers provide separate awards). All awards will be presented to the Driver, or their nominee. The Driver(s) with the highest number of points scored in accordance with these Regulations for each Challenge at the end of the season will be declared the winner(s).

SR.1.7.2 Per Event:
Trophies to the first three in Mini Se7en and Mini Miglia formulae; trophies to first three in Mini-7 S-Class and, subject to 5 entries per meeting, trophies to the first three in Mini Libre.

SR.1.7.3 Championship:
The Dunlop Mini Se7en Challenge supported by Mini Spares
1st overall: The Bob Fox Trophy (to be held for 11 months) plus replica
2nd to 10th overall: Trophies.

The Dunlop Mini-7 S-Class Challenge supported by Mini Spares
1st to 10th overall: Trophies.

The Dunlop Mini Miglia Challenge supported by Mini Spares
1st overall: The Peter Collins Trophy (to be held for 11 months) plus replica
2nd to 10th overall: Trophies.

The Dunlop Mini Libre Invitation supported by Mini Spares
1st overall: The Speciall Tuning Trophy; 2nd to 3rd overall: Trophies.

The '0-Plate' Winter Mini Challenge: In Mini Se7en & Mini Miglia - 1st to 6th overall: Trophies/Awards.
In Mini-7 S-Class - 1st to 6th overall; Mini Libre - 1st to 3rd: Trophies.

Novice award Trophies for Mini Se7en, Mini-7 S-Class and Mini Miglia classes.

The awards are open to drivers who:

- prior to the 2023 season, have not competed in more than 2 Mini Se7en, S-Class or Miglia race meetings and;
- at the start of the 2023 season are required to display a novice cross, as defined by **Q11.4.4 (in current Motorsport UK Yearbook)**.

The Awards will be made to the drivers scoring the most points in Mini Se7en, S-Class and the Mini Miglia categories. All rounds will count towards the Novice awards, and points can be gained in any Championship or

Championship qualifying race in any of the Challenges, on the following basis:

- a) 2 points to the lowest Novice finisher in a race as specified above;
- b) 1 additional point to each Novice finishing higher than the lowest placed Novice finisher on a 1-point incremental basis;
- c) If a qualification race takes place, the scoring system will be in place for both races. If a Novice automatically qualifies for the main race/final, without the need to compete in the qualification race, they will be deemed to have finished in a higher position than those competing in the qualification race;
- d) 1 point to each non-finisher Novice.

There will also be an award: The Graham Hill Memorial Trophy - for an Under-17-year-olds' category in Mini-7 S-Class; the above Novice scoring system will be adopted to determine the overall winner. Drivers must be under 17 years of age before or on the date of the first Challenge meeting of the season.

Other Annual Trophies (to be held for 11 months):

| | |
|-------------------------------------------|---------------------------------------------------------------------------------------------------------------------------|
| The Steve Bell Memorial Trophy | for the Mini Se7en or Mini Miglia driver leading the 'National' Challenge with the greater number points after six rounds |
| The Norman Finn Trophy | most Pole Positions in 'National' Mini Se7en |
| The Mike Fry Trophy | most Pole Positions in 'National' Mini Miglia |
| The Chris Inch Memorial Trophy | most Fastest Laps in the Challenges |
| The SP Trophy (<i>'Semper Paravit'</i>) | most Reliable Car in the Challenges |
| The Dunlop Cup | most Improved Driver in each formula * |
| The Chris Tyrrell (Memorial) Trophy | highest points scorer (before drop scores) in the Challenges |
| The Phil West Trophy | best turned out Mini Se7en * |
| The Peter Tisdale Trophy | best turned out Mini Miglia * |
| The <i>'best prepared'</i> S-Class Trophy | best turned out Mini-7 S-Class* |
| The Fred Jackson Memorial Trophy | Club Member of the year * |
| The Maurice Leggate Trophy | best Individual Drive of the year. * |
| The Bryan Slark Valve | Unluckiest Driver of the year * |
| The Sevenoaks Cup – Mini Se7en | highest points scorer in all races at Brands Hatch |
| The Sevenoaks Cup – Mini Miglia | highest points scorer in all races at Brands Hatch |
| The Sevenoaks Cup – M7 S-Class | highest points scorer in all races at Brands Hatch |
| The James Armstrong Memorial Trophy | for the driver finishing 11th overall in 'National' Mini Se7en |
| The Bill Sollis Trophy | 'National' Mini Se7en or Miglia runner-up scoring most 2nd places |
| The Tom Jarrett Trophy | best Racing Newcomer (non- Novice) * |
| The Frank Gillibrand Memorial Trophy | the driver best demonstrating the Original Spirit of the M7RC * |
| The Graham Edwards Memorial Trophy | the Mini 7 driver with most points who didn't quite make the podium |
| The Nick Cooke Trophy | for the Support Team of the car scoring the highest points (after drop scores) in the 'National' Challenges |
| Spax Improver Award | most places made up in the races from starting grid positions |
| The ST Trophy (<i>'Special Tuning'</i>) | best overall placings in Mini Libre Invitation |
| The M7RC Special Award | for outstanding achievement/service to M7RC* |
| The Graham Hill Memorial Trophy | highest points-scoring Under-17-year-old in Mini-7 S-Class |

* Denotes awards to be decided by end-of-season voting by M7RC Membership and/or Committee. Further awards may be announced in Official Bulletins.

- SR.1.7.4 Presentations:
Awards will be presented at the end of each event (or as soon thereafter) and/or at the end of the Challenge season at the designated Awards Ceremony. It is a condition of the Challenges that each Competitor must attend the end-of-season Awards Ceremony in order to formally claim their trophies. Non-attendance may mean forfeiture of the Trophies and/or Prize Money.
- SR.1.7.5 Entertainment Tax Liability.
If applicable, Prize money and Bonuses shall be posted to the Entrants within a reasonable time (to be notified by the M7RC) of the results being declared final after each championship season.
In accordance with current government legislation, the M7RC is legally obliged to withhold tax at the basic rate on all payments to non-UK resident sportsmen/women and account to HMRC using form **FEU1**, the quarterly return of payments made to non-resident entertainers and sportsmen/women.
That is, those persons who do not have a normal permanent residence in the UK. The UK does not include the Isle of Man, Channel Islands or Eire. This means that, as the organiser, the M7RC is required to deduct tax at the current rate applicable from any such payments they may make to non-UK residents.
Under certain circumstances, it may be possible for competitors to enter into an agreement with the Inland Revenue to limit the tax withheld. Any application for such an arrangement must be made in writing and not later than 30 days before the payment is due.
For further information contact: HMRC Personal Tax International, Foreign Entertainers Unit, St John's House, Merton Road, Liverpool L75 1BB. Tel: 0151 472 6488; Fax: 0151 472 6483.
- SR.1.7.6 Title to all Trophies:
If Provisional Results or Challenge Tables are revised after any presentations and these revisions affect the distribution of awards, the Competitors concerned must return them to the organisers in good condition within 7 days.
- SR.1.7.7 The top three Mini-7 S-Class championship finishers will be entitled to their next season's race meetings entry

fee in the Mini Se7en Championship, at a reduced fee. This prize fund is not open to anyone who has previously raced in Mini Se7ens, Mini Miglias or Mini Libre classes.

Champion – their entry fees for the 'National' rounds will be reduced by 100%

Second place – their entry fees for the 'National' rounds will be reduced by 50%

Third place – their entry fees for the 'National' rounds will be reduced by 25%

SR.1.8 MINI LIBRE (Sporting Guidelines - 2023)

SR.1.8.1 Mini Libre competitors will race alongside the Mini Miglia Challenge, on an Invitation basis (see SR.1.5.1 & SR.1.6.5).

SR.1.8.2 Mini Libre will form up on the grid behind the main Mini Miglia Challenge. For double- and treble-race meetings, SR.2.3.3 will apply.

SR.1.8.3 The best finishing positions from 17 rounds, less 3 in the 'National' Invitation, will determine the overall 2023 classification and the winner of the ST Trophy. The best finishing positions from 7 rounds, less 2 in the 0-Plate Winter Invitation, will determine the overall 2023 Winter classification.

Finishing positions in each race will be rated in line with the scoring system shown in SR.1.6.1. See SR.1.5.1. Points will not be scored in the main Challenges, and for points scoring, Challenge competitors will be ignored.

SR.1.8.4 For judicial purposes, the use of an on-board camera/s is mandatory (see SR.2.13)

SR.1.9 MINI-7 S-CLASS

SR.1.9.1 S-Class Competitors will have, prior to, or at the first event they enter, have their engine sealed. The details of the seals will be recorded and kept by the Championship Scrutineer or the nominated licensed scrutineer. Any replacement engine used will also be sealed and added to the list against that competitor. Sealing can take place any time and place during the event.

SR.1.9.2 It is the Competitor's responsibility to maintain the seals unbroken and to protect the seals from damage or loss, as the eligibility of the relevant engine depends upon the seals being in place.

SR.1.9.3 Should there be the need by the competitor to break the Motorsport UK seal or replace the engine, the competitor must inform and have written approval from the Championship Scrutineer or the nominated licensed scrutineer before the work can be carried out. At the next event the Championship Scrutineer or the nominated licensed scrutineer will check and fit new Motorsport UK seals and record details.

SR.1.9.4 It is not permitted to take part in any qualifying session or race entered under Motorsport UK permit and within M7RC championship regulations with an engine that is not sealed by the Championship Scrutineer or the nominated licensed scrutineer.

SR.1.9.5 Seals to be applied as per SR.6.6, sealing 1 (cylinder head), sealing 3 or 4 (bell housing), sealing 5 or 10 (timing cover), sealing 7 (manifold / carburettor) and sealing 8 (diff housing). Note that the rocker cover will not be sealed under this regulation.

SR.1.9.6 This sealing of S-Class engines is NOT under Motorsport UK regulations, but must remain in place for whole season including the Winter rounds. At any time, the Championship Scrutineer or the nominated licensed scrutineer can submit the relevant paperwork to the Clerk of the Course for a formal engine strip under Motorsport UK regulations of all the engines used by the competitor.

SR.1.9.7 Failure to produce an engine for inspection and/or have any broken seals, the competitor will have 2 maximum championship scores deleted (i.e. 40 points).

SR.2 CHAMPIONSHIP EVENT MEETINGS & RACE PROCEDURES

SR.2.1 ENTRIES:

- SR.2.1.1 Competitors are responsible for sending in correct and complete entries with the correct entry fee prior to the closing date for entries before each event.
Where possible, the M7RC will make available Supplementary Regulations/Entry Forms to all Registered Competitors in sufficient time for entries to be made prior to the published selection of entry dates for each Challenge round by each Organising Club. All correct and complete entries should be acknowledged within 5 working days of receipt by the Organising Club of the meeting.
- SR.2.1.2 Incorrect or incomplete entries (Including Driver to be Nominated Entries) are to be held in abeyance until they are complete and correct and the date of receipt for acceptance of entry purposes shall be the date on which the Meeting Organiser receives the missing or corrected information or fee.
- SR.2.1.3 Any withdrawal of Entry or Driver/Car changes made after acceptance of any entry must be notified to the Meeting Organisers in writing, as per **D25.1.12 and D25.1.13 (in current Motorsport UK Yearbook)**.
- SR.2.1.4 The Entry Fee for each event shall be specified in the SRs and on the entry form.
Refunds of entry fee will be as directed by the policies of the Organising Clubs as published in their Supplementary Regulations.
- SR.2.1.5 Reserves will be listed in the Final List of Entries published with Final Instructions or in a Bulletin.
- SR.2.1.6 Organising Clubs will be requested to apply the following guidelines when considering entries:
- For all entries received by the closing date, Competitors will be guaranteed an entry based on their position in their respective Challenges and the number of grid slots available.
 - For the first race of the season, the final positions in the previous season's Challenges will be used to determine priority.
 - The number of guaranteed entries available to each class will be based on 75% of the grid being guaranteed an entry, split in the ratio of the number of cars entered into each championship at the closing dates for entries.
 - All other entries will be accepted in order of receipt with full payment of entry and M7RC fees; except those who have not entered a race before in the current season and they will be considered last.
 - The closing date will be the date specified on the club's entry form or, if not specified, 14 days before the event.

Example 1 - Separate grids

*Grid 40, registered Mini Se7ens 30, registered S-Class 15
75% = 30 guaranteed places, split: Se7ens, top 20; S-Class, top 10*

Example 2 - Combined grids

*Grid 56, registered Se7ens 30, registered S-Class 15, registered Miglias 20 registered Libres 5
75% = 42 guaranteed places, split: Se7ens, top 18; S-Class, top 9; Miglias, top 12; Libre, top 3*

- SR.2.1.7 Other entries from Registered Competitors are to be accepted in order of receipt.
- SR.2.1.8 Where entries are divided into more than one heat, and/or Qualifying practice session, entries should be seeded into the appropriate groups by a competent official of The M7RC.

SR.2.2 BRIEFINGS:

Organisers should notify Competitors of the times and locations for all briefings in the Final Instructions for the meetings. Competitors must attend all briefings.

SR.2.3 QUALIFICATION PRACTICE:

- SR.2.3.1 Should any Practice session be disrupted the Clerk of the Course shall not be obliged to resume or re-run the session; the decision of the Clerk of the Course shall be final.
- SR.2.3.2 Each driver shall complete a minimum of 3 laps in the car to be raced, and in the correct session, in order to qualify, as per **Q12.4 (in current Motorsport UK Yearbook)**.
- SR.2.3.3 For all classes: For double-header meetings, the Starting Grid for Race 2 will be formed by the finishing order of Race 1, as published by the official timekeepers and subject to any judicial matters/grid penalties, but amended as follows:
The first eight (8) finishers from Race 1 shall have their grid positions for Race 2 reversed. If less than eight (8) cars are classified as finishers in Race 1, then the grid for Race 2 will be reversed down from 7th, 6th, 5th place, etc, depending on number of finishers. All other classified finishers will be allocated grid positions for Race 2 in accordance with their finishing order from Race 1.
Competitors not classified as finishers in Race 1 will start Race 2 in reverse retirement order, but in front of any competitors serving penalties, who will be placed at the back of the grid. Invitation cars are not eligible to be included in the reverse grid section. Their Race 2 grid positions will be determined by their finishing order in Race 1, but they may not be placed ahead of the first eight (8) cars on the reverse grid, or ahead of whichever number (7, 6, 5, etc) of cars form the reverse grid section.
This will apply to both individual and mixed grid combined races.

For treble-header meetings, the Starting Grid for Race 3 will be formed by the finishing order of Race 2, as published by the official timekeepers and subject to any judicial matters/grid penalties, but amended as follows: The first eight (8) finishers from Race 2 shall have their grid positions for Race 3 reversed. If less than eight (8) cars are classified as finishers in Race 2, then the grid for Race 3 will be reversed down from 7th, 6th, 5th place, etc, depending on number of finishers. All other classified finishers will be allocated grid positions for Race 3 in accordance with their finishing order from Race 2.

Competitors not classified as finishers in Race 2 will start Race 3 in reverse retirement order, but in front of any competitors serving penalties, who will be placed at the back of the grid. Invitation cars are not eligible to be included in the reverse grid section. Their Race 3 grid positions will be determined by their finishing order in Race 2, but they may not be placed ahead of the first eight (8) cars on the reverse grid, or ahead of whichever number (7, 6, 5, etc) of cars form the reverse grid section.

This will apply to both individual and mixed-grid combined races.

The organisers may use an alternative selection system and, in this case, a Championship Bulletin will be issued

- SR.2.3.4 Should more entries be accepted than are permitted to start the race (see also SR.2.11), the grids should be formed of the fastest cars in official Qualifying Practice. The remaining cars will be nominated as reserves, in order of qualifying times (see SR.2.3.6), and may replace withdrawn or retired entries in reserve number order. If Reserves are given Grid Places after publication of the grid sheet and prior to cars being collected in the Official 'Assembly Areas' they will be placed at the rear of the Grid and be started without any time delay, having been placed at the rear of the Grid in time order if more than one Reserve is to be allowed onto the grid at this time. No further Reserves will be admitted to the race after this time.
- SR.2.3.5 Reserves who take part in qualifying practice in the correct session and set a time will take precedence, in reserve number order, over any accepted entry whose qualifying times are disallowed, or who does not set a time during the official qualifying practice for the championship race
- SR.2.3.6 If both Challenge grids are to be run concurrently a representative number (ratio) of cars based on number from each category should be permitted to start, based on times recorded in official Qualifying Practice. Depending on the circuit, the Race Organisers and Championship Coordinator may confer to establish a selection procedure for slowest race reserves from each category.
- SR.2.4 RACES:**
Should any race be disrupted the nominated Clerk of the Course shall not be obliged to resume or rerun the race as per **Q12.15 (in current Motorsport UK Yearbook)**. SR.1.6.4 also applies.
- SR.2.4.1 Races will normally be held over a scheduled distance of 10 laps from a standing start in accordance with SR.2.5 and SR.2.6.
- SR.2.4.2 Race Organisers, with the consent of the Stewards of the Meeting, may shorten races should adverse weather or *force majeure* intervene.
- SR.2.4.3 Wet races will not be declared.
- SR.2.5 STARTS:**
- SR.2.5.1 All cars will be released to form up on the grid prior to the start in formation as specified on the grid sheet.
- SR.2.5.2 The start will be via Standing start (see also SR.2.5.6). The minimum Countdown procedures/audible warnings sequence shall be:
- 1-minute to start of Green Flag/Pace Lap - Start Engines/Clear Grid.
 - 30 Seconds - Visible and audible warning for start of Green Flag/Pace Lap.
 - A five-second board will be used to indicate that the grid is complete.
 - The red lights will be switched on five seconds after the board is withdrawn.
- SR.2.5.3 Any car removed from the grid after the 1 minute stage or driven into the pits on the Green Flag lap shall be held in the pitlane and may start the race after the last car has passed the startline or pitlane exit, whichever is the later to take the start from the grid.
- SR.2.5.4 Any Driver unable to start the Green Flag/Pace lap, or start are required to indicate their situation as per **Q12.11.2 (in current Motorsport UK Yearbook)**. In addition any driver unable to maintain grid positions on the Green Flag Lap, to the extent that ALL other cars are ahead of them, may complete the Green Flag lap but MUST remain at the rear of the last row of the grid but ahead of any cars to be started with a time delay.
- SR.2.5.5 In the event of any starting lights failure the Starter will revert to use of the National Flag.
- SR.2.5.6 Grids will be of 2 x 2 formation, unless the Track Licence for a particular circuit specifies a 1 x 1 formation. For combined races (Seven/S-Class and Miglia/Libre together), a grid may be formed in two parts, allowing the first part of the grid to be started in advance of the second. See **current Motorsport UK Q12.12.3**
- SR.2.5.7 Where a Race Organiser specifies a rolling start (e.g. Spa), the procedure will be specified in the Supplementary Regulations/Entry Forms and/or Final Instructions. Competitors are advised to check these carefully.
- SR.2.5.8 Excessive weaving to warm up tyres, using more than 50% of the track width and falling back in order to accelerate and practice starts, is prohibited.

- SR.2.6 SESSION RED FLAG:**
Should the need arise to stop any race or practice, RED LIGHTS will be switched on at the Startline and RED FLAGS will be displayed at the Startline and at all Marshals Signalling Points around the Circuit.
- This is the signal for all drivers to cease circulating at racing speeds, to slow to a safe and reasonable pace and to return to the pit lane, during practice, and to the starting grid area, during a race, unless otherwise directed by officials.
- Cars may not enter the Pits unless directed to do so. Work on cars already in the Pits must cease when a race is stopped.
- SR.2.7 PITS, PADDOCK & PITLANE SAFETY:**
- SR.2.7.1 Pits & Paddock: Competitors must ensure that the Motorsport UK, Circuit Management and Organising Club Safety Regulations are complied with at all times.
- SR.2.7.2 Pitlane: The outer lane or lanes are to be kept unobstructed to allow safe passage of cars at all times. The onus shall be on all Drivers to take all due care and respect the pit lane speed limits.
- SR.2.7.3 Refuelling: May only be carried out in accordance with the **Motorsport UK General Regulations**, the Organising Club Regulations, Circuit Management Regulations and the SRs or Final Instructions issued for each Circuit/Meeting.
- SR.2.7.4 Speed Limit: Pit Lane Speed Limit will be as per individual circuit/race organisers supplementary instructions.
- SR.2.7.5 Tyre changing during qualifying sessions is not permitted other than in the following circumstances:
 a) If a tyre is punctured, the punctured tyre only may be changed;
 b) Dry tyres may be changed for wet tyres and vice versa.
- SR.2.8 RACE FINISHES:**
- SR.2.8.1 After taking the Chequered Flag drivers are required to:
 a) progressively and safely slow down
 b) remain behind any competitors ahead of them,
 c) return to the Pit Lane Entrance/Paddock Entrance as instructed,
 d) comply with any directions given by Marshals or Officials
 e) keep their helmets on and harnesses done up while on the circuit or in the pitlane.
- SR.2.8.2 Only the driver and/or one other person nominated by the driver, per competing car, is permitted to access *Parc Fermé* and Post-Qualifying Practice or Post-Race Scrutineering unless otherwise notified by the Challenge Technical Scrutineer or their nominee.
- SR.2.9 RESULTS:**
All Qualifying Practice Timesheets, Grids, Race Results are to be deemed Provisional until all vehicles are released by Scrutineers after Post-Practice/Race, Scrutineering and/or after completion of any Judicial or Technical Procedures, as per **D26.3 (in current Motorsport UK Yearbook)**.
- SR.2.10 TIMING MODULES:**
At all times throughout the event, competing vehicles shall be fitted with a working timing identification module (i.e. transponder). This must be compliant with the timekeeper's equipment. The module identification number should be submitted to the Event Secretary on the entry form. It is the responsibility of the competitor to ensure that the module is working and safely fitted in a suitable position on the vehicle. Failure of the module may result in the competing vehicle being untimed. As per **Q12.8.1 (in current Motorsport UK Yearbook)**.
- SR.2.10.1 Competitors may not place electronic timing equipment within five metres of the official Start, Finish or any other official timing lines at any event or Challenge test session/day. Any such team equipment placed within these zones will be removed.
- SR.2.11 QUALIFICATION RACES:**
If any event is oversubscribed the Organising Club may, at their discretion, run Qualification Races.
- SR.2.11.1 Depending on the circuit, the Race Organisers and Championship Coordinator may confer to establish a selection procedure for Qualifying Practice, based upon the following:
- SR.2.11.2 The Challenge Race (Final) Grid may be made up of the fastest 50% (rounded up to the nearest whole number) in official timed Qualifying Practice followed by the fastest finishers in finishing order in the Qualification Race to make up the Challenge Race (Final) Grid capacity
- SR.2.11.3 Qualification Practice may take place as follows: Challenge points scorers entered for an event by the closing date may practice in alternate sessions with the Challenge leader practising in the first session, Challenge second in the second session, Challenge third in the first session and so on. Non-points scorers entered by the closing date may practice in alternate sessions in numerical order. Late entries may practice in alternate sessions in order of receipt of entry with the first received late entry in the alternate session from the highest competition number non-points scorer entered by the closing date

- SR.2.11.4 Should a Qualification Race be necessary at either of the first two rounds, practising may take place as follows. All entries entered by the closing date may practice in alternate sessions in numerical order with the lowest competition number entry practising in the first session, second lowest in the second session, third lowest in the first session, and so on. Late entries may practice in alternate sessions in order of receipt of entry with the first received late entry in the alternate session from the highest competition number entry received before the closing date
- SR.2.12 OPERATION OF SAFETY CAR:**
The Safety Car will be brought into operation and run in accordance with **Section Q, Appendix 3 of the current Motorsport UK General Regulations.**
- SR.2.13 ONBOARD CAMERAS:**
All cars must carry an on-board judicial camera, to be supplied by the competitor. The camera must be of an agreed specification capable of recording in High Definition and, at a minimum, must be able to record the Qualifying Practice session and all races. The recording must be easily downloadable onto a remote viewing device in Race Control (e.g. laptop computer, etc) via an accepted protocol such as USB connection or SD card. The camera must be mounted forward-facing so that a clear view of the track ahead can be seen. The camera should also be positioned so that the driver and steering wheel input are clearly visible on any recording. See **section J5.21 of the current Motorsport UK Regulations.**
- SR.2.13.1 The onus is on the competitor to ensure that the judicial camera is switched on and recording for all official Qualifying sessions and Races. For any camera that is not switched on during these occasions, the Competitor may incur a fine of £250 for each and every offence. Judicial cameras must not be switched on until three minutes prior to leaving the Assembly Area and must be switched off immediately after the car is released from *Parc Fermé*.
- SR.2.13.2 All camera equipment must be correctly fitted prior to Scrutineering and presented to the Scrutineers for approval. Additionally all commercial regulations imposed by the circuit and/or organiser must be adhered to. It is the competitor's responsibility to ensure that they comply with specific circuit and organiser's regulations concerning the recording of race footage.
- SR.2.13.3 All footage recorded will be collected in *Parc Fermé*, at the sole discretion of the organiser, by a representative of The M7RC. This representative will be the only person allowed to retrieve the footage from the recording equipment and no competitor or any other person should retrieve or view the footage whilst in *Parc Fermé*. The evidence from the in-car footage will be considered as a 'Judge of Fact', in accordance with **Section C, Judicial, and Part 3, Appendix 4 of current Motorsport UK Regulations.**
- SR.2.14 RADIO EQUIPMENT:**
- SR.2.14.1 Radio equipment fitted to the vehicle for training purposes ('pits-to-car communication') must be removed for all official Practice, Qualifying practice and Race sessions. See **Q11.3 (b) of current Motorsport UK Regulations.**
- SR.2.14.2 Clerk of the Course-to-Driver Communications:
A One-Way Receiver under the control of the Clerk of the Course is mandatory for all Competitors at every event in Qualifying and Races. Competitors may purchase a Raceceiver from Race Receiver UK or its nominated supplier. A Competitor not wearing a working Raceceiver in qualifying or a race will not be allowed to take their start position until rectified. If the problem is not rectified in time to take up their rightful start position a Competitor may start from the pitlane once the Raceceiver is worn and working. The Raceceiver must be connected and working until the driver reaches *parc fermé*. Raceceivers can be purchased from *Race Receiver UK, Bob Dunn, phone - 07811161616 or email - ukhire@btinternet.com*
- SR.2.15 RE-SCRUTINEERING:**
- SR.2.15.1 Any vehicle involved in an accident, or having been modified in any way, subsequent to pre-event scrutineering, must be re-presented to the Motorsport UK Scrutineers for further examination.
- SR.2.15.2 At any time during an event the Clerk of the Course, or the Scrutineers, may order that a vehicle be re-examined even if this involves stopping a vehicle whilst practicing, qualifying or racing.

- SR.3** **SPECIFIC CHAMPIONSHIP REGULATIONS:**
- SR.3.1** By registering for the Championship all competitors and their associates commit to positively promote and demonstrate the ***Motorsport UK's Respect Code*** which is appended to these regulations (***Appendix 1***) SR.6.7
- SR.3.1.1 Where any reports of disrespectful conduct are judged to be well founded the Championship organisers may issue warnings or require remedial actions and/or report the matter to the Championship Stewards who may impose appropriate penalties which can include loss of Championship points and/or race bans through to Championship Expulsion and referral to Motorsport UK.
- SR.3.1.2. It is imperative that we promote the safety and wellbeing of young people and adults at risk. In addition to this all participants must be aware of their behaviour and conduct at all times and abusive language and harmful behaviour will not be tolerated. Any such incidents must be reported to the Championship Coordinator and/or Safeguarding Officer who will also relay the report Motorsport UK. Details of the Motorsport UK Policies and Guidelines are available at **www.motorsportuk.org/resource-centre** by selecting Policies and Guidelines.
- SR.3.2** **JUDICIAL PROCEDURES**
- SR.3.2.1 SPORTING DISPUTES.
Disputes on the Sporting Regulations which arise during the season will be settled in accordance with ***current Motorsport UK Regulations***, these M7RC Regulations and any Official Bulletins issued by the M7RC or the Challenge Stewards. The case for any dispute must initially be submitted to the Challenge Co-ordinator in writing together with the appropriate Motorsport UK prescribed Protest or Appeal Fee. The Championship Stewards' judgement will be subject only to the Right of Appeal to the Motorsport UK. An Appeal against any decision issued must be submitted in writing to the Championship Stewards within 7 days of the date of dispatch of such decision, accompanied by the Motorsport UK prescribed Appeal Fee.
- SR.3.2.3 Any SR clarification/s necessary during the year will be published in Official Bulletin/s.
- SR.3.2.4 Note the requirements of SR.4.
- SR.3.3 **TECHNICAL DISPUTES.**
- SR.3.3.1 The Organisers / Promoters and the Challenge Motorsport UK Technical Commissioner and Motorsport UK Eligibility Scrutineer reserve the right to check any suspect part directly with a standard original part as previously supplied by Competition Parts or Rover Cars, or any of its nominated dealers or suppliers. The Organisers / Promoters and the Technical Commissioner and Eligibility Scrutineer also reserve the right to impound individual parts or the whole race car without prior notification. Parts or cars removed for checking elsewhere will be marked by official Motorsport UK approved seals and a certificate of sealing will be handed to the competitor or their agent. The certificate will detail the seals applied and the precautions to be taken to keep them intact. Should the Competitor or their agent not be present while the car is dismantled for checking, no dispute over the car or its components will be entertained. If any irregularity is found, or any other technical regulation is found to have been contravened, all costs associated with the necessary checking and testing will be borne by the Competitor. The competitor's membership will be suspended until all costs have been fully recovered by the club. Competitors' cars will be required to have fitted a specified number of pre-drilled bolts or studs for the affixing of Motorsport UK approved seals at any time during the season (refer to TR.5.4.3 & SR.6.6, and competitors will be required to keep the Eligibility Scrutineer informed, in writing, of any work on the car requiring a seal, or seals, to be broken, prior to commencement of such work, and in accordance with ***Motorsport UK General Regulation J3.1.6***. See also TR.5.1 and TR.5.4.2.
- SR.3.3.2 Note the requirements of SR.4.
- SR.3.4** **CLARIFICATIONS / RULINGS ON TECHNICAL REGULATIONS**
- SR.3.4.1 Competitors seeking clarification of any technical regulation must submit it in writing, with photographs if necessary, to the Motorsport UK Eligibility Scrutineer.
- SR.3.4.2 Only Clarification/s published in Official Bulletin/s issued by the M7RC are valid.

SR.4 **SPECIFIC CHAMPIONSHIP PENALTIES:**

In accordance with **Section C of the current Motorsport UK Yearbook** and as amended by these M7RC Challenge Regulations:

SR.4.1 **INFRINGEMENTS OF TECHNICAL REGULATIONS:**

SR.4.1.1 Arising from post-practice Scrutineering or Judicial Action:
Minimum Penalty: The provisions of **current Motorsport UK Regulations C3.3**.

SR.4.1.2 Arising from post-race Scrutineering or Judicial Action:
Minimum Penalty: The provisions of **current Motorsport UK Regulations C3.5.1 (a) and (b)**.

For infringements deemed to be of a more serious nature the nominated Clerk of the Course will invoke the provisions of **current Motorsport UK Regulation C3.5.1 (c)**.

SR.4.1.3 Deliberate or repeated Technical infringements will be referred to the Championship Stewards for total disqualification from the Challenges, of the Car or Entrant.

SR.4.2 **ADDITIONAL SPECIFIC CHAMPIONSHIP PENALTIES:**

SR.4.2.1 Infringements of non-Technical Regulations and the SRs issued for the 2023 Challenge in accordance with the **current Motorsport UK Regulations, Section C (Judicial)**, as amended by these M7RC Challenge Regulations:

SR.4.2.2 In order to maintain standards of conduct, the Championship Co-ordinator will monitor all officials / observers reports of adverse behaviour at race meetings. If any individual is included on two such reports during one racing season the Championship Co-ordinator will notify the organisers who will issue a written warning that their driving behaviour is to be specifically observed at future race meetings. Any adverse reports during this period of observation could result in official Motorsport UK action and will result in a Championship Stewards' enquiry, with possible loss of championship points and refusal of further race entries.

SR.4.2.3 Further specific championship penalties:

- a) Single Qualifying Practice Session, Single Race:
At any meeting, event, official qualifying or race, where any competitor shall be found guilty of any of the following offences, they shall forfeit all points in the championship gained solely at that event to the point during the event and shall be ineligible to score any points for the remainder of that event.
- b) Multiple Qualifying Practice Sessions / Multiple Race:
In the case of 'double-header' races or multi-races, where any of the following offences are committed during any qualifying practice session(s) or the first race, then points gained for the qualifying session(s) and the first race will be forfeited. Where an offence occurs during any subsequent race then the points solely gained for that race shall be forfeit.
- c) Should two separate offences be committed, then all points shall be forfeited for that whole event, irrespective of the timing of the offence committed at that event. Where a 'double-header' event takes place at the same venue over a weekend and is conducted as two separate race days then this regulation shall only apply to each day individually.

The offences are:

Driving in a manner incompatible with general safety, **current Motorsport UK Regulation C1.1.5**, where the nominated Clerk of the Course imposes a penalty greater than a reprimand;
Any offence that results in the nominated Clerk of the Course disqualifying the competitor from the race results (e.g. flag; driver behaviour).

In the event that these penalties are imposed, the nominated Clerk of the Course may decide if the competitor is obliged to count the event(s) as one contributing to their overall Challenge position.
(Refer also to SR.3.1.2).

TR.5. TECHNICAL REGULATIONS – GENERAL (Se7en, S-Class & Miglia)

TR.5.1 INTRODUCTION:

The following Technical Regulations are set out in accordance with the **current Motorsport UK specified format** and it should be clearly understood that if the following texts **do not clearly specify that you can do it** you should work on the principle **that you cannot**. Refer also to section 5 of **M7RC By-Laws**.

TR.5.2 GENERAL DESCRIPTION:

The Dunlop Mini Challenges supported by Mini Spares are organised by The M7RC as low cost introductions to Motor Racing, and are for competitors participating in classic saloon-shape Minis previously manufactured by Rover Cars, to standard specification except as permitted by these regulations, and running in all formulae:

Mini Se7en
Mini-7 S-Class
Mini Miglia

TR.5.3 SAFETY REQUIREMENTS:

TR.5.3.1 The following Articles of **current Motorsport UK Section K, Competitor Safety Regulations** will apply:

TR.5.3.2 Full Roll Cage: Free conception but must conform to the minimum specification to **current Motorsport UK K1, Drawing #3 or #5** with mandatory lateral protection. Where two diagonals in the form of a cross are used, at least one of the diagonals must be of a single piece tube. Minimum material CDS 2. Tube 38 x 2.5mm or 40 x 2.0mm. Roll Cages certified after 1st January 1996; 45.0 x 2.5mm or 50.0 x 2.0mm. Free-construction tube diameters are accepted for certification by the Motorsport UK if supported by an approved engineer's stress analysis report. Roll Cages may be welded to the bodyshell mountings conforming to **current Motorsport UK section K1**. Additional mountings are acceptable to the bodyshell. The Roll Cage must incorporate a transverse rear harness bar, either with correct bobbins inserted or, for wraparound rear harness fixing at the correct angle (see **current Motorsport UK K2** and **Appendix 2, Drawing #39**). A reinforcement between the Roll Cage, at floor level, and bolted through the front subframe rear mounts is mandatory (see *diagram below for guidance*). Forward diagonal braces across the cockpit (centre main hoop to the base of the nearside front hoop) i.e. 'Petty' Bars, are prohibited. The Cage may pass through the rear Bulkhead but cannot go beyond the rear shock absorber mounting. Any additional drilling of the Roll Cage or its reinforcements is prohibited.

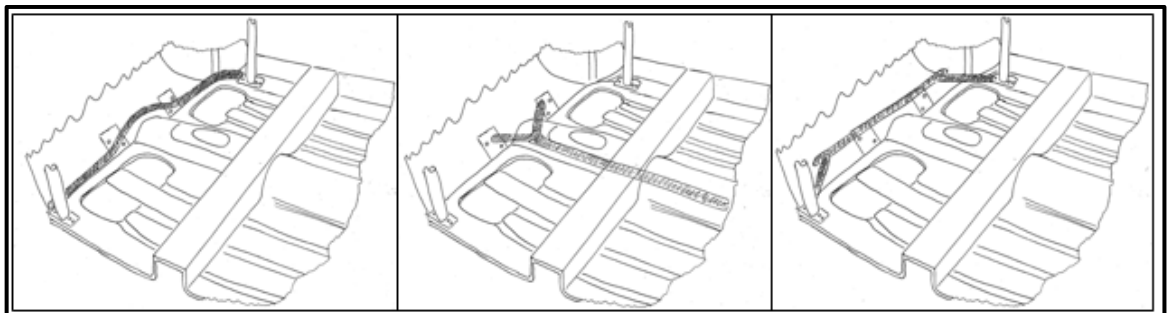

TR.5.3.3 Fire-resistant Roll Cage Padding must be installed on all parts of the cage which could come into contact with the Driver's body, arms, legs or head. F.I.A.-specification padding must be used within 150mm of the helmet. See **current Motorsport UK K1.6.6**

TR.5.3.4 Fire Extinguishers: Bottles must be securely mounted - 'jubilee clips' or webbing straps are recommended. Refer to **current Motorsport UK K3.1** and **Q13.10.7**. The exterior handle/button should preferably be located at the base of the windscreen in front of the Driver and must be adjacent to the isolator pull/switch. Both must be clearly identified by the correct 'E' and 'flash' decals. It is prohibited to recess these into bodywork or wings. It is recommended that cockpit nozzles are fitted to the top corners of the main roll hoop aimed diagonally at the foot of the front roll hoop. Under no circumstances must nozzles be directed at the Driver's face. Refer also to **current Motorsport UK K3, 3.1, 3.2, 3.3**) It is mandatory that anti-torpedo tabs fitted to brackets or straps are fitted to bottles. Refer also to **FIA Technical Lists #16 & #52**.

TR.5.3.5 Main External Circuit Breaker:

- Main External Circuit Breaker in compliance to **current Motorsport UK section K8** is mandatory.
- The switch location must be identified by a Red Spark on a white edged blue triangle, with a base of at least 12 cm, the 'On' and 'Off' positions clearly marked.
- The circuit breaker, when 'operated', must isolate all electrical circuits, data loggers, transponder, etc.
- When the circuit breaker is 'operated' there must be no power source capable of keeping the engine running.
- The triggering system for the circuit breaker should be situated at the lower part of the windscreen mounting, preferably on the driver's side, adjacent to the fire extinguisher pull.
- It is not permitted to recess the circuit breaker pull into the wing.

- TR.5.3.6 Race seat: It is recommended that seats are to **FIA 8855.1999** specification or later **FIA** specification. It is mandatory that the seat incorporates the wraparound-type shoulder/head restraints. The seat must be mounted as low as possible with correct type mounting plates, themselves fixed to a seat frame as recommended or approved. No part of the seat base may overlap the centreline of the car. See TR.5.6.1.8.
When seated the driver's helmet must have maximum clearance to any part of the roll cage. Refer to **current Motorsport UK K1.6.4 (a)**.
Any seat subject to severe accident, particularly rearwards, should be returned to its manufacturer for examination or scrapped.
- TR.5.3.7 A 5- or 6-point FIA-approved safety harness is mandatory. The lap and crutch mounting points must be fixed to the seat mounting frame with the shoulder harness fixed to a transverse tube between the two rear hoop supports. The strap angle to the driver's shoulders should be no greater than 20°.
- TR.5.3.8 It is recommended that the Drivers' window, if open at any time during practice or the race, is fitted with a net.
- TR.5.3.9 Throughout any competition, practice or race, Drivers must wear an approved helmet together with approved overalls, boots and gloves, as per **current Motorsport UK Q12.1.1 (a) and (c)**. The wearing of approved underwear, socks, and balaclavas is strongly recommended. Any nylon for shirts and underwear or trainer-type boots is prohibited.
An FIA-approved FHR (Frontal Head Restraint) device, fitted in accordance with **FIA regulations**, is mandatory, as per **current Motorsport UK Q12.1.1 (e)**
- TR.5.3.10 Towing Eyes meeting the requirements of **current Motorsport UK Regulation Q13.1.3** are mandatory. Towing eyes should be painted a contrasting bright colour and marked with an arrow and the word "TOW".
- TR.5.3.11 A rearward facing light meeting **current Motorsport UK K5** must be fitted on the centre-line of the car. This must be between the top of the rear window and no lower than the horizontal plane at the lower edge of the rear lights. Under no circumstances may light be reflected into the car.
- TR.5.3.12 All cars must have fitted two external wing mirrors, mounted in the original manufacturer position on the doors; refer to **current Motorsport UK Q13.11.1**. In addition, cars must have fitted at least one internal rear view mirror.
- TR.5.3.13 All cars must be fitted with an operative windscreen wiper, as per **current Motorsport UK Q13.11.3**.
- TR.5.4 GENERAL TECHNICAL REQUIREMENTS & EXCEPTIONS:**
- TR.5.4.1 Eligible Cars are all classic saloon-shape Minis to standard production specification, excluding Clubman and other derivatives, previously manufactured by Rover Cars (see TR.5.17.4.9). No other cars are eligible. No modifications are permitted except as specified hereafter.
- TR.5.4.2 Notwithstanding these Technical Regulations it is the Competitor's responsibility to ensure that their car complies **with current Motorsport UK Technical Regulations (Section J)** and **(Section Q)** as appropriate and the Supplementary Regulations throughout the event.
- TR.5.4.3 Competitors' cars will be required to have fitted a specified number of pre-drilled bolts or studs for the affixing of Motorsport UK approved seals at any time during the season (refer to SR.3.2.1 & SR.6.6).
- TR.5.5 CHASSIS:**
The classic saloon-shape Mini has monocoque construction with separate subframes. Any references to bodyshell in these regulations do not include subframes.
- TR.5.6 BODYWORK:**
- TR.5.6.1 Modifications Permitted (to include the following):
General
Interior
Exterior
Silhouette
Ground Clearance (see TR.5.8.2.7)
- TR.5.6.1.1 A standard steel production bodyshell unaltered in major internal or external dimensions or appearance is mandatory (see TR.5.4.1). A 'standard production' bodyshell can be one that is repaired, or constructed from new, by whichever method is suitable, but that any replacement panel or panels required is/are to original standard production form, both in terms of material (where specified) and dimensions.
Front and rear bulkheads and sills must remain unaltered but may be reinforced. Rear bulkhead may be modified to allow the cage, electrical cables, fuel and brake cables to pass through.
The rear parcel shelf and the dash panel/shelf (which may incorporate an air box) may be replaced. Any replacement must be properly sealed and secured to form an adequate firewall. Where replacement materials are used these must have reinforced attachments at maximum 50mm spacing.

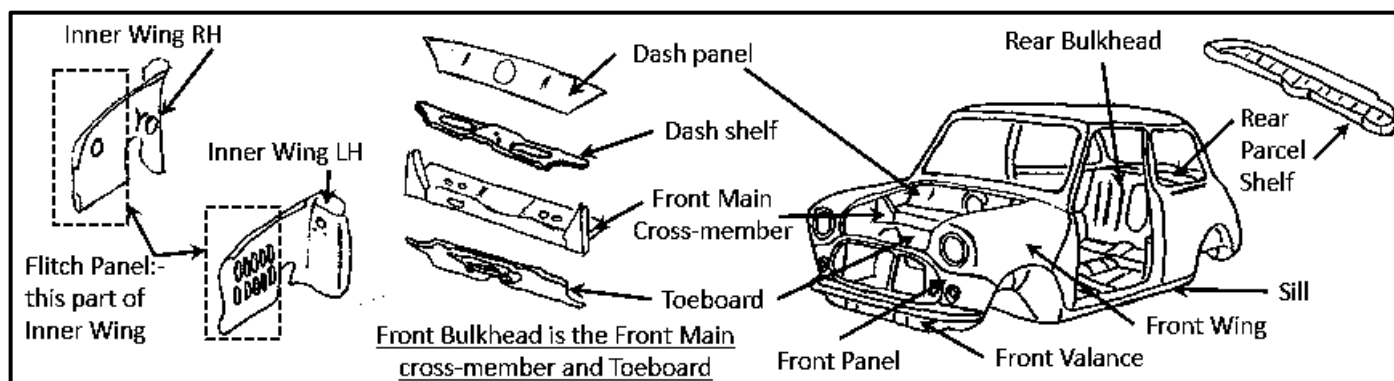

TR.5.6.1.2 Steel body panels must be retained and remain to standard shape.

TR.5.6.1.3 Bonnet, front wings, front panel and boot lid may be replaced by pattern components retaining original shape with only material change - GRP, Carbon/Kevlar or Aluminium. It is essential that the front subframe is effectively triangulated to the front main cross-member on both sides, when removing the standard steel wings or inner flich panels.

TR.5.6.1.4. Windscreens, if glass, must be laminated. Polycarbonate or similar alternative is permitted for windscreens, door, side or rear windows; Minimum thickness - 4mm. Holes in windows are prohibited except for a single aperture in the Driver's window - maximum diameter 20cm for ventilation (it is recommended not a square hole). It is permitted for rear quarter windows to be open (similar to a road car) during qualification and a race.

TR.5.6.1.5 The standard pattern and material grille, surrounds and bumpers must be retained. The grille must not be spaced from the surrounding bodywork.

TR.5.6.1.6 It is permitted to close floor holes, drain holes, etc.

TR.5.6.1.7 The rear valance may be removed.

TR.5.6.1.8 It is permitted to reinforce and weld seat rail supports to floor, tunnel and sills. However, no modifying/cutting of the Centre Tunnel may exceed beyond the centreline of the car. See TR.5.3.6.

TR.5.6.1.9 All carpeting, sound-deadening material, under-dash rubber padding and interior trim must be removed.

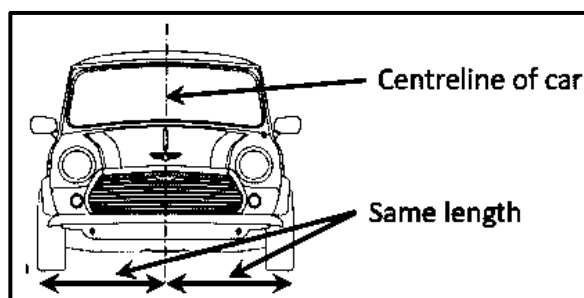

TR.5.6.1.10 Door pockets (Mk1; Mk2) may be removed, later door panels may be reduced. Modified (lightened) doors must have a panel closing the door aperture and either be solid foam-filled or filled with carbon/aluminium honeycomb inserts. A filling inspection-hole is required.

TR.5.6.1.11 External front wheel arches and production rear wheel arches may be modified for tyre clearance. Rear wheel arches may also be modified to allow for anti-roll bar drop links. All edges must be rolled and sealed. The original rear shock absorber platform must always remain in its original position, and the measurement between both rear shock absorber platform locating holes must be within +/-10mm tolerance of 970mm. See also TR.5.6.1.2 and TR.5.6.1.17.

TR.5.6.1.12 The boot floor may be removed or replaced but must not become an aerodynamic aid. See also TR.5.15.2.3.

TR.5.6.1.13 Instruments and instrument panels must not present sharp edges or intrusion to driver safety at any time.

TR.5.6.1.14 The addition of plates to the accelerator, clutch or brake pedals is permitted.

TR.5.6.1.15 Nuts, bolts, studs, washers and locking devices may be freely exchanged.

TR.5.6.1.16 The bonnet release mechanism must be removed and the bonnet secured by quick-release pins, Dzus fasteners or another acceptable method.

TR.5.6.1.17 Wheel spats (arches) in ABS plastic, GRP, Aluminium or Carbon Fibre must be fitted securely to wing/body panels. Alloy edges must be rolled. The spat must cover the complete tyre (including sidewall), viewed from above with the wheels in the straight ahead position.

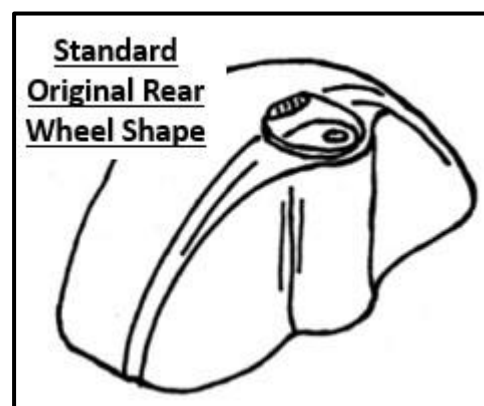

TR.5.6.1.18 The production Mini steel subframes, or identical pattern replacements, must always respect standard integrity and dimensions. They may be lightened and reinforced with additional material. Mounting points to the bodyshell may be reinforced but must remain in the production positions. Additional mountings are permitted. The front subframe turrets and bump-stop platforms must remain unaltered, except the turrets which may be modified for the sole purpose of shock absorber clearance. The rear subframe rear rail may be lightened, inverted or replaced by a tube but not removed. Bump-stop platforms may be modified.

TR.5.6.2 Modifications Prohibited (to include the following):
General
Interior
Exterior
Silhouette
Ground Clearance (see TR.5.8.2.7)

TR.5.6.2.1 Reworking or modification to the bodyshell except where specified is prohibited.

TR.5.6.2.2 External holes in the bodywork other than those of original manufacture are prohibited.

TR.5.6.2.3 Reworking, replacement or modification to the inner bodywork, including the inner rear wheel arches, except where specified, is prohibited. See TR.5.6.1.1. (see diagram below).

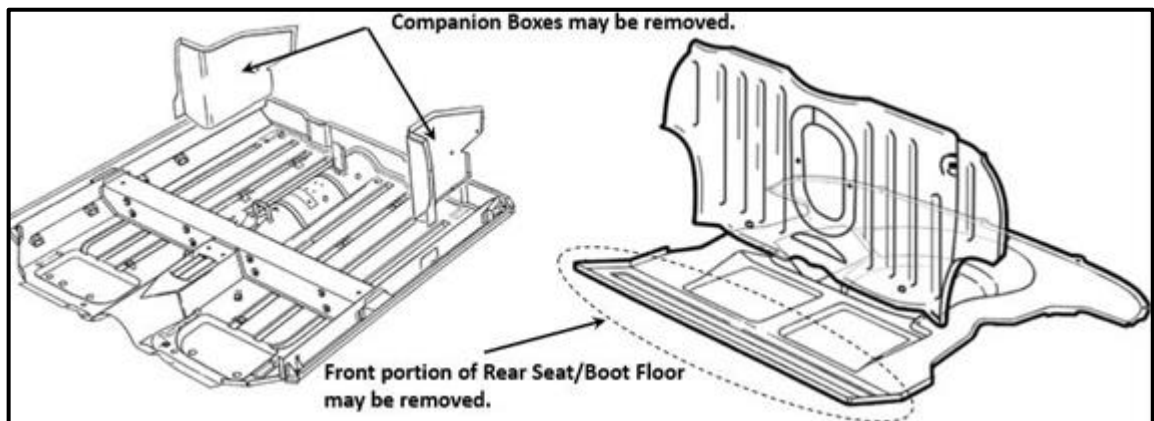

TR.5.6.2.4 It is not permitted to remove the primary floor cross-members. They may be modified for seat mountings.

TR.5.6.2.5 It is not permitted to remove door sills, either inner or outer.

TR.5.6.2.6 Reworking or modification to the exterior bodywork, except where specified, is prohibited.

TR.5.6.2.7 Radiators for oil or coolant must remain within the engine compartment. Oil radiators may be below the engine compartment, licked by the air stream.

TR.5.6.2.8 The extinguisher and electrics isolator pulls must not be recessed into body or wings.

TR.5.6.2.9 It is prohibited to enclose the front or rear subframes, i.e. streamlining.

TR.5.6.2.10 Front air dams or any form of aerodynamic aids are prohibited.

TR.5.6.2.11 It is prohibited to remove or modify the front valance in any way.

TR.5.6.2.12 It is forbidden to reinforce or introduce additional metal to front or rear bumpers.

TR.5.6.2.13 The silhouette including body flanges and gutters must remain as standard. Body flanges (front or rear) cannot be replaced or angled rearwards. Minimum 9.5mm exposed flange must remain. Finisher trims may be removed.

TR.5.7 ENGINE:

TR.5.7.1 Cylinder head gasket is free. WARNING: The volume is included within the minimum unswept volume and varies according to type used. The special version of gasket GUG 2507HG with reinforcing rings to the cylinder area requires machining to the block face and is unsuitable.

TR.5.7.2 Fuel Delivery systems are free. Unless continuous metal lines are fitted, braided Fuel lines with screw connections are mandatory within the cockpit.

TR.5.7.3 Oil Accumulator systems are prohibited.

TR.5.7.4 Coolant additives are permitted

- TR.5.7.5 As some anti-freeze fluids (undiluted) are flammable, it is recommended that a mixture of water and anti-freeze is used as coolant; reduces flammability.
- TR.5.7.6 Dry Sump Lubrication by any method is prohibited.
- TR.5.7.7 The engine must remain in the original position but the means of fixing are free.
- TR.5.7.8 Under no circumstances should standard cast iron clutch back plates be used.
- TR.5.7.9 Magnesium/magnesium-alloy castings or forgings for gearbox castings, transfer casings and/or bellhousings are prohibited.
- TR.5.7.10 Forced induction is prohibited (i.e. no turbochargers or superchargers).

TR.5.8 SUSPENSION

- TR.5.8.1 The system of operation for Shock Absorbers and position of the original supports must not be changed. The front shock absorber top bracket can be modified, but the bracket's fixing points to the bodyshell cannot be modified. The original rear shock absorber mount top platform cannot be modified or moved.

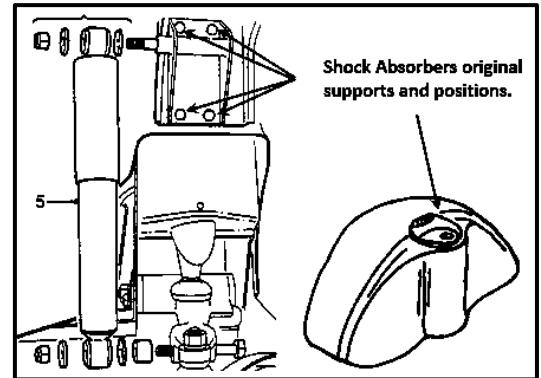

- TR.5.8.2 Suspension Mounting points and location to subframe must remain in their original positions. Additional mounting points between subframe and bodyshell are permitted.

- TR.5.8.3 Auxiliary Springs are prohibited.

- TR.5.8.4 Anti-roll bars, if fitted, must not be adjustable from inside the car.

- TR.5.8.5 Alteration of the wheelbase is prohibited (adjustment for caster is accepted).

- TR.5.8.6 Ride Height: Minimum 4cm at all times, racing trim with Driver aboard.
See **current Motorsport UK Regulation J5.20.11**.

TR.5.9 TRANSMISSION:

- TR.5.9.1 Only standard A-Series 4-speed casings are permitted. Magnesium / magnesium-alloy castings are prohibited.
- TR.5.9.2 Normally operating Reverse Gear mandatory: A reverse-gear lock is permitted but the Driver must be able to select reverse when seated normally.
- TR.5.9.3 Any form of traction control is prohibited. A single-speed sensor is permitted on one rear wheel only, for road speed measurement only.
- TR.5.9.4 Any form of sequential control is prohibited.
- TR.5.9.5 Any form of Ceramic Bearings is prohibited.

TR.5.10 ELECTRICS:

- TR.5.10.1 An operating charging system is mandatory. This must be means of an alternator/dynamo driven off the engine.
- TR.5.10.2 It is permitted that Front Side Lights are not required to be fitted or to operate.
- TR.5.10.3 Indicator lamps must be fitted but need not operate.
- TR.5.10.4 Battery position and type are free. If located in the cockpit the battery must be securely bolted by straps to the floor within a fixed non-conductive box, excluding Lithium batteries. Battery terminals must be covered/insulated.
- TR.5.10.5 Head lights, Rear and Brake lights must be operational at all times.
- TR.5.10.6 Further modifications are unrestricted.

TR.5.11 BRAKES:

- TR.5.11.1 Disc Pad and Shoe Lining Material is free. Shoe Lining thickness should be continuous.
- TR.5.11.2 Minifin or Super Minifin or similar brake drum replacements are permitted.
- TR.5.11.3 Cockpit brake-balance adjuster valves are permitted but must be in accordance with **current Motorsport UK Reg Q13.4. note (c) "Brake balance adjusters must not be available for adjustment during running"**

TR.5.12 WHEELS / STEERING:

- TR.5.12.1 Steering Wheel must conform to **current Motorsport UK J5.7.1 and J5.7.2**. A 'quick-release' removable type is permitted, however the spline attachment to the column must have a spigot, not be butt-welded.
- TR.5.12.2 The Steering Column may be fitted with a single, suitable, proprietary universal joint at the lower steering rack joint. A fabricated column support is permitted (no plastic or nylon brackets), however it must be secure and be fully padded with no protruding edges or bolts.
- TR.5.12.3 Standard Steering Column must be retained (maximum length 695mm, may be cut but not extended). May be modified in accordance with TR.5.12.1 and TR.5.12.2.

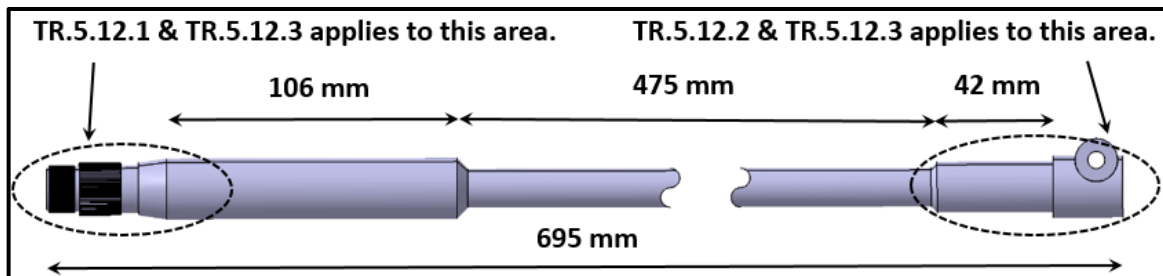

- TR.5.12.4 Wheel Nut torque must not exceed 38-43lb/ft. It is recommended to have all wheels regularly crack-tested.

TR.5.13 TYRES:

- TR.5.13.1 The following is mandatory:
 - TR.5.13.1.1 Nominated Manufacturer: Dunlop
 - TR.5.13.1.2 All treaded tyres must have a minimum of 1.6mm of tread remaining at the start of any qualifying practice or race
 - TR.5.13.1.3 The use of tyre heating/heat retention devices, tyre treatment and compounds treatment is prohibited

TR.5.14 WEIGHTS:

- TR.5.14.1 Minimum Racing Weight means the weight of the car and Driver, including any remaining liquids, at the end of qualifying and/or race. (see 'Specific Regulations' for actual weights of each Class: TR.5.18, TR.5.19, TR.5.20)
- TR.5.14.2 Permitted Ballast: Maximum 25kg.
Ballast must be a solid mass fixed with a minimum of 4 bolts to the passenger seat floor area.
The bolts must be drilled to permit the Motorsport UK Eligibility Scrutineer to attach wire and seals if required.

TR.5.15 FUEL TANK / FUEL:

- TR.5.15.1 Type of Tank is free, but should be foam filled or a F.I.A.-specification bag tank in a metal box. It must have a secure filler cap. See **current Motorsport UK K14.1.2**.
- TR.5.15.1.1 Capacity is free, but must have at least 3 litres remaining at the end of race/qualifying.
See **current Motorsport UK D34.1.4** and **D34.2.1**. Alternatively 1 litre minimum, but the competitor forfeits their right to appeal a fuel test result, see **current Motorsport UK D34.2.2** and **D34.2.3**.
- TR.5.15.2 Locations:
 - TR.5.15.2.1 Fuel Tank must be securely located in boot.
 - TR.5.15.2.2 Tank Mountings are free and must be secure.
 - TR.5.15.2.3 Safety: The fuel tank must be protected from the exhaust and any boot floor must have drainage for fuel spillage.
External fuel level indicator e.g. 'sight glass' is prohibited.
Fuel Pump must be positioned as close as possible to the rear bulkhead.
- TR.5.15.3 Fuel:
 - TR.5.15.3.1 Only commercial pump fuel, to BSEN228 (unleaded) or BS7800 (Super Unleaded) fuel max RON 100, to be used, without any separate additives is permitted. See **current Motorsport UK Section B** for 'pump fuel' definition. LRG (LRP) fuel is not in compliance with the above standards and may not be blended or used. Equally the specified additives for LRG (LRP) to reduce valve seat regression are not permitted.

TR.5.16 SILENCING:

TR.5.16.1 Specification:

TR.5.16.1.1 The Exhaust System tailpipe/s must exit at the rear of the car, but must not protrude beyond the rear bumper, and must end no shorter than 6" / 150mm from the end of the rear bodywork.

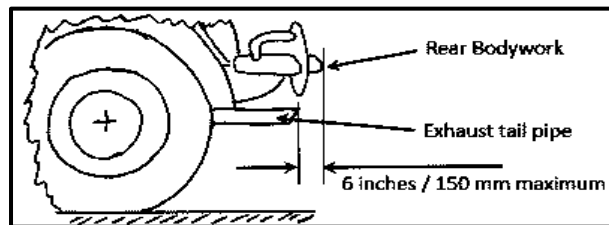

TR.5.16.2 It is the Competitor's responsibility at all times to ensure the car meets obligatory **current Motorsport UK J.5.17** for testing, qualifying or race.
Current Motorsport UK maximum level 105 dBA (see Motorsport UK Appendix 1, Chart 5.18)

TR.5.17 NUMBERS & CHAMPIONSHIP IDENTIFICATION:

TR.5.17.1 Both car and Driver must meet the following requirements of livery during all practice, qualifying and races;

TR.5.17.2 Note the particular requirements of SR.6.2.

TR.5.17.3 Two title sponsor's number panels and windscreen headers as supplied and unaltered. The door panels must be placed squarely on the doors and no further back than the front edge of the door handles. The appropriate windscreen header for the class must be fitted to the top of the front 'screen'. Competitors registered for the main Challenges will be allocated numbers below #100 except where agreed with the Challenge organisers. Competitors in the S-Class category will be allocated numbers from #700-799. Competitors invited to race in accordance with SR.1.6.5 will be allocated three-figure race numbers. These numbers will be allocated from #100 upwards.
See **current Motorsport UK J4.1, J4.1.4, J4.1.5, J4.1.8 and J4 (Drawing 4)**, and also **current MsUK Q11.4**.

Competitors are reminded that forward-facing competition numbers must also be carried in accordance with **current Motorsport UK Regulations**.

TR.5.17.4 The following sponsors' decals must also be carried on each car (see TR.5.17.4 defining 'side of the car');

TR.5.17.4.1 Two (x2) DUNLOP / MINI SPARES Title Sponsor / Co-Sponsor door number panels and one windscreen header (see TR.5.17.3). In addition, one (x1) MINI SPARES decal inside the car and clearly visible when viewed on camera in-car footage.

TR.5.17.4.2 Two (x2) M7RC decals (optional), one forward-facing & one rearward-facing.

TR.5.17.4.6.3 One (x1) PIPER CAMS decal, forward facing.

TR.5.17.4.4 The 'side of the car' is defined as follows;
All areas of the rear quarter, A-panel and door above the sill flange (Line A). Plus, the area of the front wing below the projection of the bodyline described by Line B, the area of the roof described by Line C and the area of the rear panel described by Line D (see drawing below).

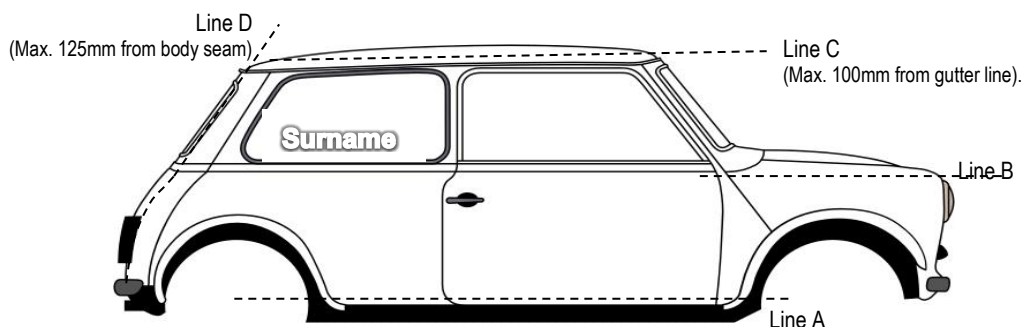

TR.5.17.5 Driver's names:

i) All classes;

Surname only must appear on each rear quarter light window, letters in white without background (Fluorescent Orange, *Pantone reference: 804C2X* for Novices and Under-17 category), in Helvetica Bold typeface, upper and lower case (i.e. Surname, not SURNAME). The maximum height for the uppercase letter is 100mm. The letters should be fitted a minimum 30mm from the lower edge of the window

ii) Where two Drivers alternate in the same car, the appropriate names may appear on a Perspex panel which must be securely fitted to the inside of the rear quarter light windows of the car. The unused Driver name must be removed or neatly covered with black tape.

iii) Christian names will only be approved by the Challenge Organisers in cases where more than one Driver with the same Surname registers for the Challenges.

TR.5.17.6 The M7RC has the right to refuse to accept any livery and order repainting if the required standards are not met, see SR.6.3.6.

TR.5.18 **SPECIFIC TECHNICAL REGULATIONS – MINI SE7EN**

TR.5.18.1 **CHASSIS:**

No additional regulations.

TR.5.18.2 **BODYWORK:**

No additional regulations.

TR.5.18.3 **ENGINE:**

TR.5.18.3.1 Oil and Coolant Radiators are free (see TR.5.6.2.7).

TR.5.18.3.2 An original production Rover Cars A-Series five-port head casting must be fitted which may be modified by polishing and machining only to combustion chambers, ports and machined faces.

TR.5.18.3.3 Exhaust manifolds are free.

TR.5.18.3.4 Standard production A-Series 998cc cylinder block is mandatory.
Bore 64.58mm x Stroke 76.2mm (2.543" x 3.00"). Maximum bore wear tolerance 0.005"
Maximum bore size permitted 65.08mm / 2.563". Block may be re-lined when worn.
Cylinder block may be machined to allow valves to open.

TR.5.18.3.5 Crankshaft must have the standard stroke of 76.20mm (3.00") and standard width crank journals. All bearing journals must respect OEM dimensions with respect to position on crankshaft.

TR.5.18.3.6 Camshaft: Only the unmodified M7 6648 camshaft (obtainable strictly via M7RC) is permitted. Each camshaft will be serial-numbered and logged to individual competitors/ entrants. Cam timing is free. Set valve clearance to 0.015" 0.4mm to check lift. Method of camshaft drive is free.

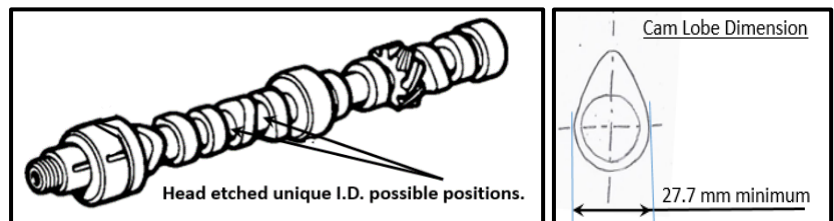

TR.5.18.3.7 Camshafts must remain in their original position and be the sole means of operating the valves. No modifications are permitted. Variable camshaft timing prohibited.

TR.5.18.3.8 Rocker assemblies are free but must conform to the maximum valve lift 0.330" / 8.38mm.

TR.5.18.3.9 Magnesium cast and forged pistons are prohibited, otherwise pistons are free.

TR.5.18.3.10 Minimum unswept volume is 24.0cc.

| | |
|-----------------------------------------------------------------------------------------------|---------|
| For example: | |
| Cylinder Head Combustion Chamber. | 12.2cc. |
| Cylinder Head Gasket. | 3.8cc |
| Minimum piston dish and cylinder volume (at TDC) | 8.0cc. |
| Total (minimum unswept volume) = | 24.0cc. |
| i.e. if cylinder/piston volume is less, the combustion chamber must increase, and vice versa. | |

TR.5.18.3.11 Any single-choke carburettor is permitted.
To Clarify: Fuel injection prohibited.

TR.5.18.3.12 a If a single-choke carburettor is used, or a single barrel of a multi-choke carburettor is used, a single restrictor of maximum bore 1.5" / 38.1mm fitted between the carburettor and manifold is mandatory in the fuel flow. The restrictor must maintain the maximum bore over a minimum length of 3mm / 0.12". The restrictor must be made of non-porous material. Total length is free.

TR.5.18.3.12 b A Weber 45 DCOE carburettor is permitted, maximum bore diameter 45mm, maximum choke size 38mm. The carburettor must be fixed directly to the inlet manifold using only a Misab 'O' Ring / Gasket.

TR.5.18.3.13 Ignition systems are free. However, other than a crank sensor it is forbidden to add additional sensors (i.e.temperature, airflow, etc.) or throttle potentiometers, this includes vacuum feeds.

TR.5.13.3.14 Any ferrous con rods with original centres (5.75" / 146.06mm) are permitted (includes Cooper 'S'). Titanium is prohibited.

TR.5.18.3.15 Clutch spring/cover plate must be standard pattern, i.e. CP-2084-31 'orange' or CP-2084-32 'grey', or CP-2084-42 'double grey'. The engine must use the starter ring attached to flywheel.

- TR.5.18.3.16 Inlet valve maximum diameter 35.7mm; Inlet Valve diameter (see Dimension A).
- TR.5.18.3.17 Inclination of valves, or ports of the cylinder head, by any means are prohibited.
- TR.5.18.3.18 Titanium inlet or exhaust valves and/or push rods are prohibited.
- TR.5.18.3.19 Further Modifications are free.

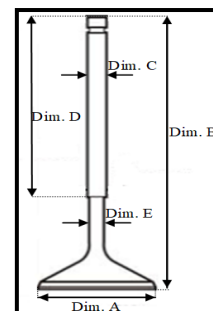

TR.5.18.4 **SUSPENSION:**

- TR.5.18.4.1 Suspension geometry may be altered, by using modified standard parts or ferrous proprietary components. Production series Top Arms must remain unaltered. Non-ferrous or Titanium suspension components are prohibited. Rear radius arms must not be lightened or modified except that the brake hose bracket may be removed.
- TR.5.18.4.2 Anti-roll bars are permitted.
- TR.5.18.4.3 The vehicle may be lowered by alteration of cone/doughnut only. Alloy cones (trumpets) e.g. 'hi-lo adjusta' type, may be used. The subframe must not be 'cut-and-shut'. i.e. front towers must not be reduced in height. See TR.5.6.1.18.
- TR.5.18.4.4 The Track can be changed by altering camber and caster only.
- TR.5.18.4.5 Shock Absorbers must be of similar design and construction to those fitted to the production specification Mini but may have a facility for adjustment of bump and rebound damping by a single adjuster. Single- or twin-tube tube design is permitted.

TR.5.18.5 **TRANSMISSION:**

- TR.5.18.5.1 Gear ratios (maximum 4) and final drive ratios are free.
- TR.5.18.5.2 The gearchange lever assembly may be relocated within the cockpit, however, the floor/bulkhead must always be a closed firewall.
- TR.5.18.5.3 Locked, Torque-Reducing or any form of Limited Slip Differential is prohibited.

TR.5.18.6 **ELECTRICS:**

No additional regulations

TR.5.18.7 **BRAKES:**

- TR.5.18.7.1 Pedal position. Where the original pedal assembly is replaced by a pedal box (floor-mounted or otherwise), with the pedals in their free position, the minimum distance from the pedal (including any plate or block attached thereto) to the crossmember's forward face is 300mm, crossmember remaining in its original position. Brake/Clutch fluid remote reservoirs are prohibited from the cockpit.

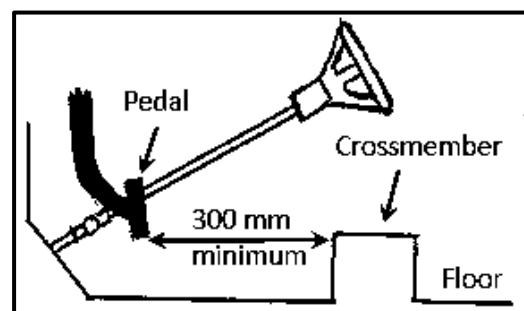

- TR.5.18.7.2 Hand Brake; unless fitted with twin circuit braking system, an operational Hand Brake is mandatory.

- TR.5.18.7.3 Brakes are limited to:
 - i) Cooper 'S' Discs and Calipers - discs with up-to-12 wiper grooves may be allowed; maximum 6-grooves-per-disc face
 - ii) Standard 7" Rear Drum systems only
 Vented discs and/or drilled/cross-drilled discs are prohibited. Carbon discs are prohibited.

TR.5.18.8 **WHEELS / STEERING:**

- TR.5.18.8.1 A single 1" spacer is permitted on each rear wheel except where one-piece drums (i.e. with spacer included) are fitted.
- TR.5.18.8.2 Only wheels STR1082 (100+), MA1050D (Minilite) and C-21A1901 A (MS), with the correct wheel nuts are permitted. Note: check wheel nut penetrates the wheel a minimum of 10mm. If necessary, machine the hexagonal flange. It is strongly recommended that wheels are crack tested regularly. Also, powder-coating the reverse side of the wheel hub and spokes, should be discouraged as it hides the area where signs of cracking can be seen.
- TR.5.18.8.3 Wheel dimensions: 5J x 10".

TR.5.18.9 **TYRES:**

TR.5.18.9.1 Cars must use treaded tyres of 500L x 10 size. These may be CR70 or CR65 tread pattern
In CR70 tread pattern only 204 compound tyres must be used on the front wheels while either 204 or 484 compound tyres may be used on the rear wheels.
In CR65 tread pattern only 484 compound tyres must be used, on both front and rear wheels.
It is not permitted to run a mix of CR70 and CR65 tread pattern tyres on the car at any time.

TR.5.18.10 **WEIGHTS:**

TR.5.18.10.1 Minimum Racing Weight, including the driver, is 660kg.

TR.5.18.11 **FUEL TANK / FUEL:**

No additional regulations.

TR.5.18.12 **SILENCING:**

TR.5.18.12.1 The mandatory exhaust system must comprise either:
a) One STR 1069, or two for a twin system.
b) A complete RC40 system with both silencers in-line (front round - rear oval), or two complete RC40 systems for a twin system. The silencer box Entry / Exit pipes must not be modified within 1cm of the box. Internal modifications to the mandatory silencer boxes are prohibited.
c) One Maniflow part number CLRH 06, or two for twin system.

TR.5.18.13 **NUMBERS & CHAMPIONSHIP DECALS:**

TR.5.18.13.1 One (x1) SPAX decal, on both front wings.

TR.5.18.13.2 One (x1) CURLEY decal, on both front wings

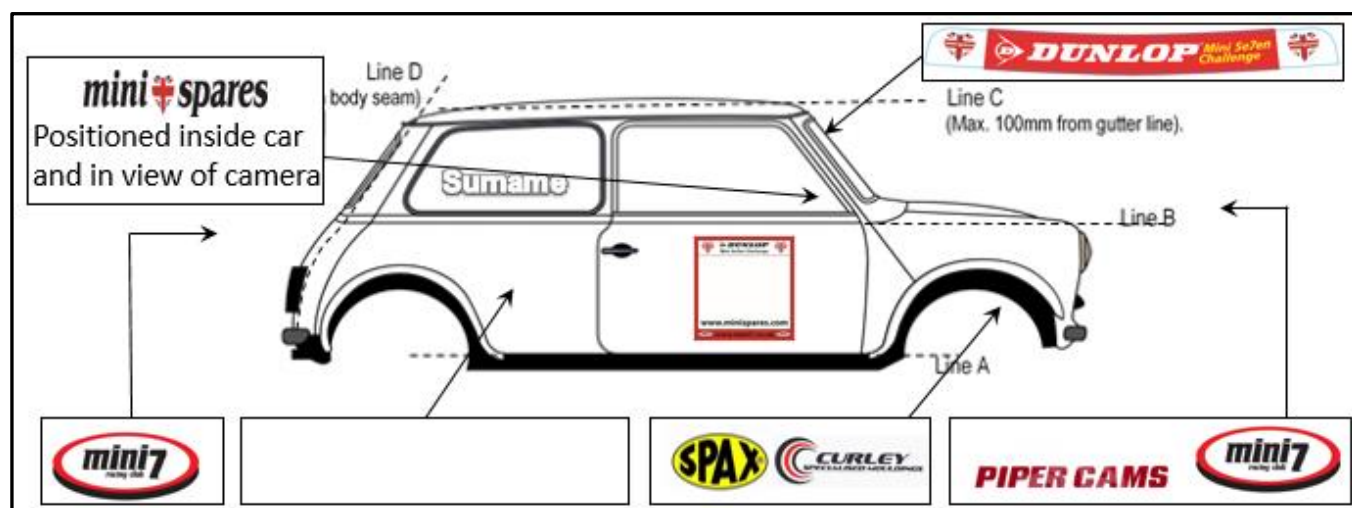

TR.5.19 **SPECIFIC TECHNICAL REGULATIONS – MINI 7 S-CLASS**

TR.5.19.1 **CHASSIS:**

No additional regulations.

TR.5.19.2 **BODYWORK:**

No additional regulations.

TR.5.19.3 **ENGINE:**

TR.5.19.3.1 Coolant radiators are free.

TR.5.19.3.2 Mechanical and electric water pump permitted.

TR.5.19.3.3 Dry decking is prohibited (*see diagram*)

TR.5.19.3.4 i) An original production Rover Cars A-Series five-port head casting, unmodified (any type of blast cleaning of the air passages is prohibited), but may have the block mating face surface finish only.

Production cylinder head thickness 69.85 / 69.47mm.

To Clarify: An original 1275cc production Rover Cars cylinder head, not copies. Valve seat inserts on the exhaust only.

Three (3) angle valve seats allowed but the valve seat cutter should not increase the original cut into the chamber casting surface (Inlet 39.12 maximum diameter and Exhaust 34.29 maximum diameter). Maximum valve diameter 33.3mm inlet, 29.4mm exhaust. Where necessary, cylinder heads may be drilled and tapped at the thermostat end to allow fitment of a temperature sensor. The heater take-off at no.4 end may be drilled and tapped for fitment of coolant pipes. Head may be drilled to allow 11 head studs. Non-original valve guides may be used of standard length (43.11 / 42.60mm) and fitted height (13.97 / 13.46mm) as production (unless specified). No modifications to valve spring seats. Any non-original parts used must respect OEM dimensions.

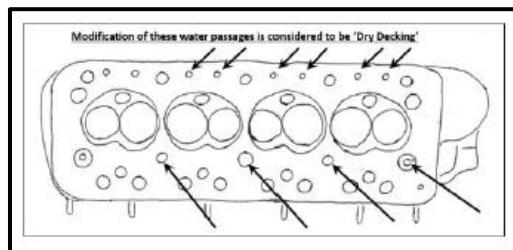

Three (3) angle valve seats allowed but the valve seat cutter should not increase the original cut into the chamber casting surface (Inlet 39.12 maximum diameter and Exhaust 34.29 maximum diameter). Maximum valve diameter 33.3mm inlet, 29.4mm exhaust. Where necessary, cylinder heads may be drilled and tapped at the thermostat end to allow fitment of a temperature sensor. The heater take-off at no.4 end may be drilled and tapped for fitment of coolant pipes. Head may be drilled to allow 11 head studs. Non-original valve guides may be used of standard length (43.11 / 42.60mm) and fitted height (13.97 / 13.46mm) as production (unless specified). No modifications to valve spring seats. Any non-original parts used must respect OEM dimensions.

TR.5.19.3.5 Inclination of valves, or ports of the cylinder head, by any means is prohibited.

TR.5.19.3.6 Standard production 1275cc A-Series or A+ cylinder block mandatory. May be rebored, and/or have the head mating face surface finish only (production block height 225.83 / 225.58mm). The gearbox mounting holes may be machined to take 5/16 or 8mm bolts.

Bore 70.62mm Stroke 81.3mm (2.78" x 3.20").

To Clarify: To surface-finish the cylinder head deck face, means clean-up/levelling only.

Bores must be square to block face and in original position.

Any bore liners must be of Rover OEM material, i.e. spun iron with no coatings.

Permitted modifications for ease of maintenance and reliability: Fitting of core plug straps; threaded oil gallery plugs; chamfering of oil gallery to align bearing feed in main bearing shells.

TR.5.19.3.7 Maximum bore oversize 71.12 (0.5mm) / 2.80". Block may be re-lined when worn, but with liners must be spun iron with no coatings. Maximum bore wear tolerance 0.005".

TR.5.19.3.8 Standard centre main bearing cap must be retained but may be machined to accept a steel strap and, for reliability, pre- A+ main shells, fixings free.

TR.5.19.3.9 Standard production 1275cc EN16T crankshaft (non-replica, stroke 81.3 mm [3.2 inch]), may be heat treated, reground and balanced. Main and big end bearings and journals must remain standard width. TR.5.19.3.10 Standard con rods: Three (3) may have their weights changed to suit one (un-altered rod) with un-machined small end/big end and no signs of machining to the rod itself.

To Clarify: Standard production 1275cc con rods must be used with original centres of 5.75". No bushes fitted to the small end. The small end cannot be honed out or resized to allow a standard diameter gudgeon pin to become a 'floating'-fit pin. One (1) con rod must remain standard, i.e. no balancing to the big end or small end. The big ends may be 'capped and honed' to resize to original internal diameter if they are oval.

TR.5.19.3.11 Camshafts must remain in their original position and be the sole means of operating the valves. No modifications are permitted. Variable camshaft timing prohibited.

TR.5.19.3.12 Camshaft: Only the unmodified M7 6648 camshaft (obtainable strictly via M7RC) is permitted. Each camshaft will be serial-numbered and logged to individual competitors/ entrants. Cam timing is free.

Set valve clearance to

0.015"/0.4mm to check valve lift. Method of camshaft drive is free.

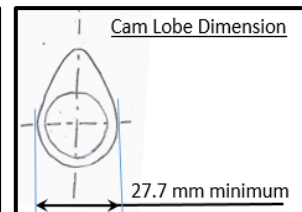
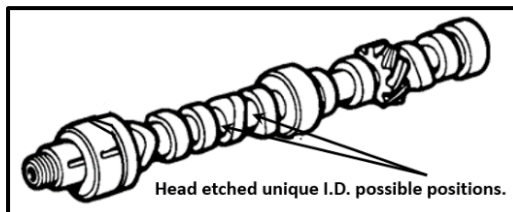

TR.5.19.3.13 Standard A+ steel push rods are mandatory.
To Clarify: *Unmodified in any way, as fitted to a 1275cc standard production block.*

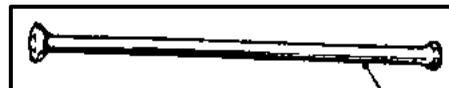

TR.5.19.3.14 Rocker assemblies are free but must conform to the maximum valve lift 0.330" / 8.38mm.

TR.5.19.3.15 Magnesium cast or forged pistons are prohibited otherwise pistons are free, but must feature:
3 piston ring grooves – fitted with rings.
OEM standard diameter press-fit gudgeon (wrist) pin (20.6mm / 13 / 16 / 0.8125")
Maximum piston skirt diameter: 2.8"
Minimum compression height: 1.498"

TR.5.19.3.16 Minimum unswept volume = 33cc
To Clarify: *Unswept volume = 33cc must include head gasket and spark plugs, as used in race spec.*
For example:

| | |
|--------------------------------------------------|--------|
| Cylinder Head Combustion Chamber | 20.7cc |
| Cylinder Head Gasket | 3.8cc |
| Minimum piston dish and cylinder volume (at TDC) | 8.5cc |
| Total (minimum unswept volume) = | 33.0cc |

i.e. if unswept volume is less, use the piston only.

TR.5.19.3.17 Single-choke Carburettor with a maximum choke size 36mm, mounted directly to the inlet manifold with no spacers or restrictors. 'O' rings (IE 'Misab' carb-mounting 'O' ring plates) only permitted. Fixings are free. A multi-choke carburettor may be used with one choke isolated.
To Clarify: *Fuel injection prohibited.*

TR.5.19.3.18 An enclosed air cleaner, attached directly to the carburettor, is permitted. Any other ducting is prohibited.

TR.5.19.3.19 The ignition distributor must be mounted in its original position. Ignition advance/retard must only be controlled by 'bob weights', spring, and/or vacuum means within the distributor. The low tension switching of the ignition system shall only be with a contact breaker or contact-less system (i.e. 'Hall effect' or light sensitive system) housed within the distributor body.
To Clarify: *A distributor must be used and mounted in its original position. Some ignition systems use an external amplifier, this is permitted. Multi-coil systems i.e. wasted spark and programmable systems are prohibited.*

TR.5.19.3.20 Mandatory Manifold LCB exhaust manifold. Part number LM 004 SII.

TR.5.19.3.21 Mandatory Manifold single steel Weber inlet manifold LI54 (with nominal 38.1mm / 1.5" Port runner diameter).
To clarify: *only the Manifold standard stock 'horseshoe-type' 1.5" O/D outside diameter (nominal 1.4" I/D inner diameter), and marked with 'M7S', is permitted.*

TR.5.19.3.22 Steel flywheel only. Minimum weight 8lb / 3.63kg
To Clarify: *Minimum weight of flywheel to include straps and bolts. Centre Bolt and Locking Washer are NOT part of the flywheel.*

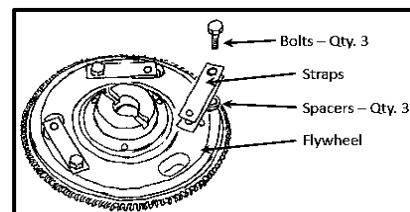

TR.5.19.3.23 Steel back plate only. Minimum weight 1.2kg
To Clarify: *Minimum weight of back plate/pressure plate does NOT include bolts.*

TR.5.19.3.24 Titanium inlet or exhaust valves and/or push rods are prohibited.
Inlet Valve diameter (*Dimension A*) 33mm maximum 33.33mm
Exhaust valve diameter (*Dim' A*) 29.4mm maximum 29.69mm
Valve stems minimum 7.00 mm diameter.
Valves to be standard Rover Mini OEM length, as fitted to 1275cc engines.
To clarify:
Valve overall length (*Dim' B*) 89.77 / 91.58mm or 3.53 / 3.61"
Valve stem minimum diameter (*Dim' C*) 7.00mm / 0.2784"
The valve stems are allowed to be waisted (see diagram)
'Waisted Stem' valves are permitted but must comply with the following dimensions:
Minimum length of valve stem before waisted section (*Dim' D*) 60.20mm / 2.370"
Minimum diameter of waisted section (*Dim' E*) 6.30mm / 0.248"

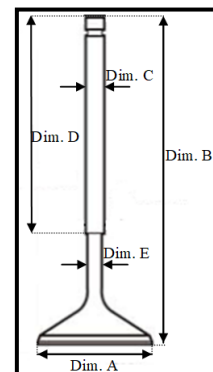

TR.5.19.3.25 Valve spring length is free, double valve springs are permitted, no tapered springs.
Valve springs must be visually similar in profile to standard production items.
Spring poundage and spring rates are free.

TR.5.19.3.26 Titanium/aluminium valve spring caps prohibited.

TR.5.19.3.27 Valve spring shims can be used. 'Roller bearing' type (or similar style) valve spring shims are prohibited.

TR.5.19.4 **SUSPENSION:**

TR.5.19.4.1 Suspension geometry may be altered, by using modified standard parts or ferrous proprietary components. Production series Top Arms must remain unaltered. Non-ferrous or Titanium suspension components are prohibited. Rear radius arms must not be lightened or modified except that the brake hose bracket may be removed.

TR.5.19.4.2 Rear Anti-Roll Bar is permitted.

TR.5.19.4.3 The vehicle may be lowered by alteration of cone/doughnut only. Alloy cones (trumpets) e.g. 'hi-lo adjusta' type, may be used. The subframe must not be 'cut and shut'. i.e. front towers must not be reduced in height. See TR.5.6.1.18.

TR.5.19.4.4 The Track can be changed by altering camber and caster only.

TR.5.19.4.5 For the front axles, it is mandatory to use a Spax Shock Absorber, part no. G3275. A steel-bodied Mini Racing Damper which is adjustable.

For the rear axles, any Steel-bodied Shock Absorber is permitted, but must be of similar design and construction to those fitted to the production specification Mini but may have a facility for adjustment of bump and rebound damping by a single adjuster.

TR.5.19.4.6 Any form of ball-joint spacers and/or tie-bar drop links (droppers) are prohibited.

TR.5.19.5 **TRANSMISSION:**

TR.5.19.5.1 Original standard production unmodified Rover Cars 'A-Series' transverse 4 synchromesh helical gears are mandatory. The four (4) permitted complete gearset combinations with corresponding gear tooth counts are:

| | Gearset | 1st | 2nd | 3rd | 1st Motion | Laygear |
|-----|---------------------------------|-----------------------|-----------------------|-----------------------|------------------------------|----------------|
| (a) | Four-Sync, A+ standard UK ratio | 31 | 26 | 21 | 17 | 15-21-26-30 |
| (b) | Four-Sync, A+ 'Economy' ratio | 31 | 25 | 20 | 16 | 15-21-27-31 |
| (c) | Four-Sync, S/GT ratio | 31 | 26 | 21 | 18 | 15-20-25-29 |
| (d) | Four-Sync, Pre A+ | 31 | 26 | 21 | 17 | 15-20-25-29 |

Original standard production unmodified Rover Cars 'A-Series' helical drop gears in a 1:1 ratio are mandatory. The two (2) permitted drop gear combinations with their corresponding gear tooth count are:

| | Drop gear type | Crank Primary Gear | Idler Gear | Gearbox Input Gear |
|-----|----------------------------------|---------------------------|-------------------|---------------------------|
| (a) | A+ (with 0.875" idler shaft) | 29 | 37 | 29 |
| (b) | Pre A+ (with 0.750" idler shaft) | 24 | 31 | 24 |

Original standard production unmodified Rover Cars 'A-Series' helical final drive gears in a 3.647:1 ratio are mandatory. Crownwheel: 62 tooth Pinion: 17 tooth

| | Crownwheel type | Tooth Count | Part Number | Casting number |
|-----|------------------------|--------------------|--------------------|-----------------------|
| (a) | Crownwheel (A+) | 62 | DAM4162 | DAM4163 |
| | Pinion (A+) | 17 | DAM4131 | |
| (b) | Crownwheel (Pre A+) | 62 | 22G940 | |
| | Pinion (Pre A+) | 17 | 22A399 | |

All the above gears remain in their original standard production state and any modifications are prohibited, that includes polishing gear teeth and machining crown wheels.

TR.5.19.5.2 The gearchange lever assembly may be relocated within the cockpit, however, the floor/bulkhead must always be a closed firewall. The standard lever ratio must be retained e.g. no 'quick-shifts'.

TR.5.19.5.3 Locked, Torque-Reducing or any form of Limited Slip Differential is prohibited.

TR.5.19.5.4 Windage trays are prohibited (i.e. any device / deflector plate between the engine and gearbox).

TR.5.19.6 **ELECTRICS:**

TR.5.19.6.1 Standard production alternator and charging system must remain unaltered and operational. *To Clarify: Alternator must be similar in type and design to those fitted to the Rover Production Mini. Lightweight/race alternators are prohibited. That is any Austin/Morris/BMC/British Leyland/Austin Rover Group/MG Rover Group Mini and NOT any alternator from another manufacturer's production car. Starter motors are free but must be fitted in the original mounting holes.*

TR.5.19.7 **BRAKES:**

TR.5.19.7.1 The standard pedal assembly and a single master cylinder assembly must remain.

TR.5.19.7.2 Standard Hand Brake with cables to each rear drum must remain operational.

- TR.5.19.7.3 Brakes are limited to:
 i) Cooper 'S' Discs and Calipers - discs with up-to-12 wiper grooves may be allowed; maximum 6-grooves-per-disc face
 ii) Standard 7" Rear Drum systems only
 Vented discs and/or drilled/cross-drilled discs are prohibited. Carbon discs are prohibited.
- TR.5.19.8 **WHEELS / STEERING:**
- TR.5.19.8.1 Standard steering arms bolted directly to the hubs without any form of spacer are mandatory.
- TR.5.19.8.2 A single 1" spacer is permitted on each rear wheel except where one-piece drums (i.e. with spacer included) are fitted.
- TR.5.19.8.3 Only wheels STR1082 (100+), MA1050D (Minilite) and C-21A1901 A (MS), with the correct wheel nuts are permitted.
 Note: check wheel nut penetrates the wheel a minimum of 10mm. If necessary, machine the hexagonal flange. It is strongly recommended that wheels are crack tested regularly. Also, powder-coating the reverse side of the wheel hub and spokes, should be discouraged as it hides the area where signs of cracking can be seen.
- TR.5.19.8.4 Wheel Dimensions: 5J x 10"
- TR.5.19.9 **TYRES:**
- TR.5.19.9.1 The following is mandatory:
 Cars must use treaded tyres of 500L x 10 size. These may be CR70 or CR65 tread pattern
 In CR70 tread pattern only 204 compound tyres must be used on the front wheels while either 204 or 484 compound tyres may be used on the rear wheels.
 In CR65 tread pattern only 484 compound tyres must be used, on both front and rear wheels.
 It is not permitted to run a mix of CR70 and CR65 tread pattern tyres on the car at any time.
- TR.5.19.10 **WEIGHTS:**
- TR.5.19.10.1 Minimum Racing Weight, including driver, is 680kg
- TR.5.19.11 **FUEL TANK / FUEL:**
- No additional regulations.
- TR.5.19.12 **SILENCING:**
- TR.5.19.12.1 Specification;
 Complete Manifold system – LCB Manifold and link pipe are mandatory
 The link pipe and silencer box pipes may be modified for chassis clearance only
 The silencer box Entry / Exit pipes must not be modified within 1cm of the box. Internal modifications to the mandatory silencer box are prohibited.
 LCB Manifold. Part number – LM 004 SII
 Link pipe. Part number – LP 04 B
 Silencer box. Part number CLRH 06
- TR.5.19.13 **NUMBERS & CHAMPIONSHIP DECALS:**
- TR.5.19.13.1 One (x1) SPAX decal, on both front wings.
- TR.5.19.13.2 One (x1) CURLEY decal, on both front wings.

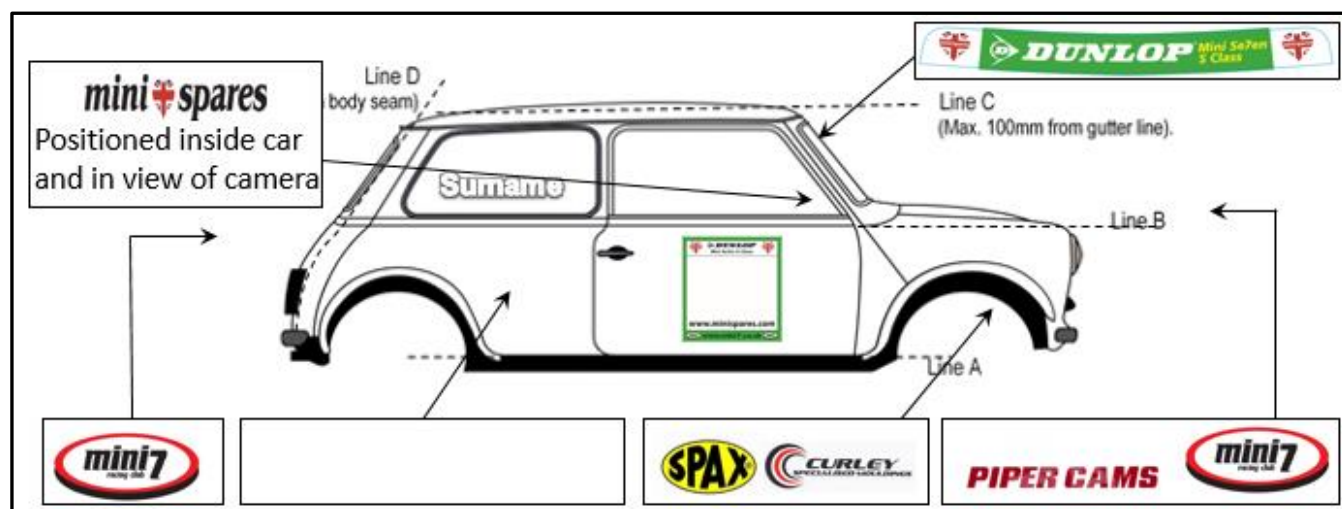

TR.5.20 **SPECIFIC TECHNICAL REGULATIONS – MINI MIGLIA**

TR.5.20.1 **CHASSIS:**

No additional regulations.

TR.5.20.2 **BODYWORK:**

No additional regulations.

TR.5.20.3 **ENGINE:**

TR.5.20.3.1 Oil and Coolant Radiators free (see TR.5.6.2.7).

TR.5.20.3.2 An original production Rover Cars A-Series five-port head casting must be fitted which may be modified by polishing and machining only to combustion chambers, ports and machine faces.

TR.5.20.3.3 Exhaust manifolds are free.

TR.5.20.3.4 Standard A-Series 1275cc cylinder block is mandatory.
Bore 70.62mm x Stroke 81.30mm (2.78" x 3.20"). Maximum bore wear tolerance 0.005"
Maximum Bore size permitted; 71.12mm / 2.80". Block may be re-lined when worn.

TR.5.20.3.5 Crankshaft must have the standard stroke of 81.30mm (3.20") and standard width crank journals. All bearing journals must respect OEM dimensions with respect to position on crankshaft.

TR.5.20.3.6 Mandatory Camshaft.
Only the unmodified MM930 camshaft (obtainable strictly via M7RC) is permitted. Each camshaft will be serial-numbered and logged to individual competitors / entrants.

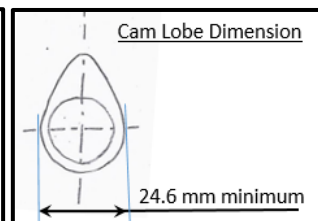
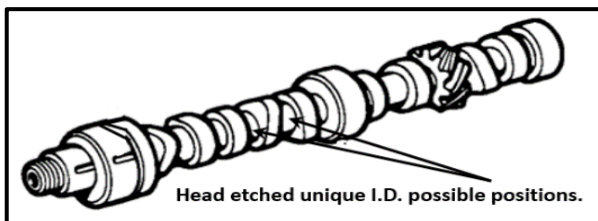

Cam timing is free. Set valve clearance to 0.015"/0.4mm to check valve lift. Method of camshaft drive is free.

TR.5.20.3.7 Rocker Assemblies are free but must conform to the maximum valve lift 0.425" / 10.8mm. Valve springs and caps are free.

TR.5.20.3.8 Magnesium cast or forged pistons are prohibited otherwise pistons are free.

TR.5.20.3.9 Minimum unswept volume is 32.0cc.
For example:
Cylinder Head Combustion Chamber. 16.0cc.
Cylinder Head Gasket. 3.8cc
Minimum piston dish and cylinder volume (at TDC). 12.2cc
Total (minimum unswept volume) = 32.0cc
i.e. if cylinder piston volume is less the combustion chamber must increase.

TR.5.20.3.10 The only permitted carburettors are:
Single Weber 40DCOE; 45DCOE; Dellorto 45 DHLA; Solex 40ADDHE or twin SU.
Maximum throttle butterfly diameter 45mm.
To Clarify: Fuel injection prohibited.

TR.5.20.3.11 Ignition systems are free. However, other than a crank sensor it is forbidden to add additional sensors (i.e. temperature, airflow, etc.) or throttle potentiometers, this includes vacuum feeds.

TR.5.20.3.12 Any ferrous con rod with original centres (5.75" / 146.06mm) are permitted (includes Cooper 'S'). Titanium is prohibited.

TR.5.20.3.13 Clutch spring/cover plate must be standard pattern i.e. CP-2084-31 'orange', or CP-2084-32 'grey', or CP-2084-42 'double grey'. The engine must use the starter ring attached to flywheel.

TR.5.20.3.14 Inlet valve maximum diameter 35.7mm; Inlet Valve diameter (see *Dimension A*).

TR.5.20.3.15 Inclination of valves, or ports of the cylinder head, by any means is prohibited.

TR.5.20.3.16 Camshafts must remain in their original position and be the sole means of operating the valves. No modifications are permitted. Variable camshaft timing prohibited.

TR.5.20.3.17 Titanium inlet or exhaust valves and/or push rods are prohibited.

TR.5.20.3.18 Further modifications are free.

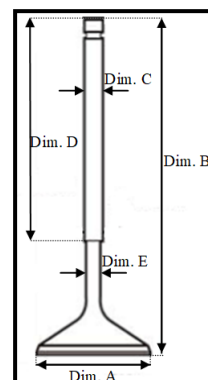

TR.5.20.4 **SUSPENSION:**

TR.5.20.4.1 Suspension geometry may be altered, by using modified standard parts or ferrous proprietary components. Production series Top Arms must remain unaltered. Non-ferrous or Titanium suspension components are prohibited. Rear radius arms must not be lightened or modified except that the brake hose bracket may be removed.

TR.5.20.4.2 Rear Anti-Roll Bar is permitted.

TR.5.20.4.3 The vehicle may be lowered by alteration of cone/doughnut only. Alloy cones (trumpets) e.g., 'hi-lo adjusta' type, may be used. The subframe must not be 'cut and shut'. i.e. front towers must not be reduced in height. See TR.5.6.1.18.

Only a standard single control rubber cone (Mini Spares Yellow Dot – Part # C-STR688, obtainable strictly via M7RC) must be used with a maximum 25mm hole in the centre for HiLo clearance and adjustment, no other modifications are allowed. Each cone will be serial-numbered and logged to individual competitors / entrants.

TR.5.20.4.4 The Track may be changed.
Maximum track permitted: Front 1375mm, Rear 1300mm.
Measurements to be taken as follows;
Use two pieces of 4" x 2" and take measurement between A and B.

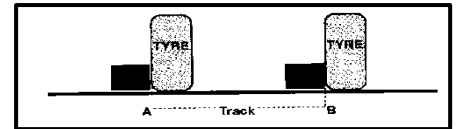

TR.5.20.4.5 For the rear axles, Steel or Alloy monobloc tube design Shock Absorbers must be of similar design and construction to those fitted to the production specification Mini. A facility for adjustment of bump and rebound damping is allowed, by either a single adjuster, or by two separate adjusters (normally known as Double adjustable). Single- or twin-tube tube design is permitted. Remote fluid reservoirs are prohibited. For the front axle, it is mandatory to use the Ohlins single adjustable, steel bodied damper, part number MMF5Q000, supplied by BG Motorsport, according to the M7RC control specification whereby piston configuration, internal valving, oil viscosity and gas pressure are fixed. The shaft and body length is free to allow for individual fitment length. The control dampers are sealed and serialised. The seal must remain intact (excepting cases of *force majeure*). All repairs and servicing must be conducted by BG Motorsport.

TR.5.20.4.6 Any form of tie-bar drop links ('droppers') are prohibited.

TR.5.20.5 **TRANSMISSION:**

TR.5.20.5.1 Gear ratios (maximum 4). The ratio for First gear is free, the following range of ratios are mandatory; 2nd – 1: 1.568 - 1.486, 3rd – 1: 1.1865 - 1.244, 4th - 1: 1.1 ratio drop gears are mandatory.
A 14-tooth pinion and 55-tooth crown wheel (nominal 3.9:1 final drive) is mandatory.

TR.5.20.5.2 The gearchange lever assembly may be relocated within the cockpit, however, the floor/bulkhead must always be a closed firewall.

TR.5.20.5.3 A M7RC regulation Automatic Torque Biasing (ATB) unit, supplied by the M7RC, is mandatory. Each ATB will be serial numbered and logged to individual competitors / entrants. The ATB will run with Standard pattern crown wheel. Output shafts from the ATB are Pot joint-compatible. (If Hardy Spicer Units are utilised then a simple pop-on converter can be used, these utilise the std. A+ output covers rather than the larger Cooper S covers).

TR.5.20.6 **ELECTRICS:**

No additional regulations.

TR.5.20.7 **BRAKES:**

TR.5.20.7.1 Pedal position. Where the original pedal assembly is replaced by a pedal box (floor mounted or otherwise), with the pedals in their free position, the minimum distance from the pedal (including any plate or block attached thereto) to the crossmember's forward face is 300mm, crossmember remaining in its original position.
Brake/Clutch fluid remote reservoirs are prohibited from the cockpit.

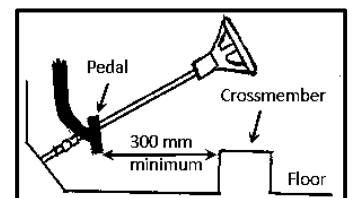

TR.5.20.7.2 Hand Brake; unless fitted with twin circuit braking system, an operational Hand Brake is mandatory.

TR.5.20.7.3 Brakes are free except:
i) Carbon discs are prohibited
ii) Rear disc brakes are prohibited
iii) Maximum number of front caliper pistons - 4 per caliper.

TR.5.20.8 **WHEELS / STEERING:**

TR.5.20.8.1 Steel or Alloy materials are permitted. Alloy Wheels must be secured by sleeve-type nuts only.

Note: Refer to the wheel manufacturer for maintenance procedures, particularly for modular / split rims.

TR.5.20.8.2 Wheel dimensions: 10-inch Diameter with a maximum 7-inch wide rims (see TR.5.6.1.17).

TR.5.20.9 **TYRES:**

TR.5.20.9.1 The following is mandatory:

Cars may use slick (dry weather) or treaded (wet weather) factory-cut tyres to a pattern approved by the Championship, of size 160/490 x 10.

The compound is free. If used, the 599 compound (or any replacing it) can only be used at the rear. It is not permitted to run a mix of slick (dry weather) and treaded (wet weather) tyres on the car at any time.

TR.5.20.10 **WEIGHTS:**

TR.5.20.10.1 Minimum Racing Weight, including the driver, is 670kg

TR.5.20.11 **FUEL TANK / FUEL:**

No additional regulations.

TR.5.20.12 **SILENCING:**

TR.5.20.12.1 The mandatory exhaust system must comprise either:

- a) One STR 1069, or two for a twin system.
- b) A complete RC40 system with both silencers in-line (front round - rear oval), or two complete RC40 systems for a twin system. The silencer box Entry / Exit pipes must not be modified within 1cm of the box. Internal modifications to the mandatory silencer boxes are prohibited.
- c) One Manifold part number CLRH 06, or two for twin system.

TR.5.20.13 **NUMBERS & CHAMPIONSHIP DECALS:**

TR.5.20.13.1 'deleted'

TR.5.20.13.2 One (x1) CURLEY decal, on both front wheel arches

TR.5.20.13.3 'deleted'

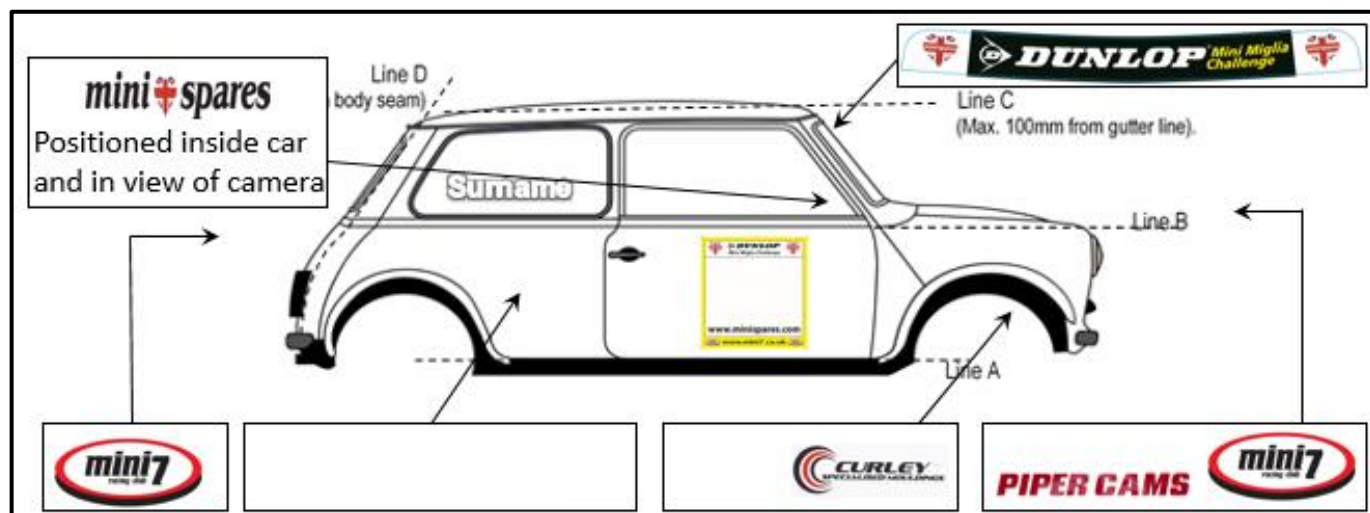

- TR.5.21** **SPECIFIC TECHNICAL GUIDELINES – MINI LIBRE Invitation**
- TR.5.21.1 **INTRODUCTION:**
- TR.5.21.1.1 All cars and drivers must comply with Motorsport UK Safety requirements (see TR.5.3).
Apart from TR.5.3.2 where it states “A reinforcement between the Roll Cage, at floor level and bolted through the front subframe rear mounts is mandatory” to read “is strongly recommended”.
In addition, the Cage may pass beyond the rear shock absorber mountings.
- TR.5.21.1.2 The M7RC reserves the right to add further detailed technical guidelines during the season.
- TR.5.21.2 **CHASSIS:**
- No additional guidelines.
- TR.5.21.3 **BODYWORK:**
- TR.5.21.3.1 Cars must follow the silhouette of the classic saloon Mini; allowances will be made for modifications to the bonnet for clearance. However, spaceframe, van, pick-up and clubman variants will not be eligible.
- TR.5.21.3.2 Grille, surrounds and bumpers must be retained.
- TR.5.21.3.3 Steel roof mandatory.
- TR.5.21.3.4 Door material is free, but must conform to TR.5.6.1.10 or must have foam protection.
- TR.5.21.3.5 The following apply: - TR.5.6.2.4, TR.5.6.2.5 & TR.5.6.2.12
- TR.5.21.4 **ENGINE:**
- TR.5.21.4.1 An A-Series engine block and gearbox is mandatory. Any form of sequential control/gearshift is prohibited (see TR.5.9.2.3).
- TR.5.21.4.2 The maximum engine capacity shall be 1400cc.
- TR.5.21.4.3 Forced induction is prohibited (i.e. no turbochargers or superchargers).
- TR.5.21.4.4 Oil and Coolant Radiators are free (see TR.5.6.2.7).
- TR.5.21.4.5 Competitors’ cars will be required to have fitted a specified number of pre-drilled studs for affixing of Motorsport UK approved seals at any time during the season. Only sealing the cylinder head and flywheel / bellhousing (refer to SR.3.2.1 & SR.6.6 ‘Sealing 1 – cylinder head’, ‘Sealing 2 – Rocker cover’ and ‘Sealing 3 -Flywheel / Bellhousing’). Non 5-port headed engines can have alternative methods of sealing the cylinder head, using the Motorsport UK seals.
- TR.5.21.5 **SUSPENSION:**
- TR.5.21.5.1 Suspension geometry may be altered, Rear radius arms (production cast steel design) must not be lightened or modified except that the brake hose bracket may be removed.
- TR.5.21.6 **TRANSMISSION:**
- No additional guidelines.
- TR.5.21.7 **ELECTRICS:**
- TR.5.21.7.1 An operating charging system is mandatory. This must be by means of an alternator/dynamo driven off the engine.
- TR.5.21.8 **BRAKES:**
- No additional guidelines.
- TR.5.21.9 **WHEELS / STEERING:**
- TR.5.21.9.1 The following to apply: - TR.5.12.1
- TR.5.21.9.2 10-inch diameter wheels are mandatory.
- TR.5.21.10 **TYRES:**
- TR.5.21.10.1 Dunlop tyres are mandatory.

TR.5.21.11 **WEIGHTS:**

TR.5.21.11.1 The Minimum Racing Weight, including driver is to be as follows:

- i) 5-port iron head, as Miglia (i.e. 670 kg).
 - ii) 7-ports, 8-ports and 16 valves, 20kg above Miglia minimum running weight (i.e. 690kg).
- Additional ballast may be added to selected cars, subject to performance.

TR.5.21.12 **FUEL TANK / FUEL:**

The following to apply: - TR.5.15.2.3

TR.5.21.13 **SILENCING:**

TR.5.21.13.1 No additional guidelines

TR.5.21.14 **NUMBERS & CHAMPIONSHIP DECALS:**

TR.5.21.14.1 M7RC sponsor decals, plus Mini Libre windscreen header and door squares are mandatory.

TR.5.21.14.2 Drivers' rear quarter window names must follow the M7RC font and size (see TR.5.17).

TR.5.21.14.3 Race numbers will be allocated on a three-figure basis (excluding #700-799).

TR.5.21.14.4 'deleted'

TR.5.21.14.5 One (x1) CURLEY decal, on both front wheel arches

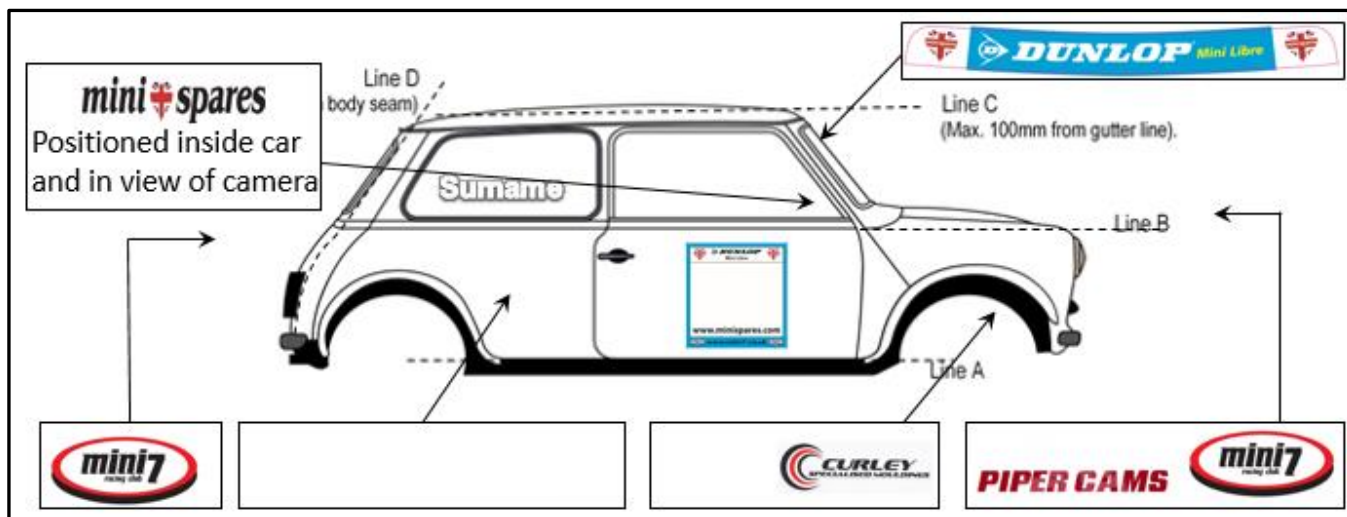

SR.6 APPENDICES

The following Commercial Undertakings are not subject to the Judicial procedures of either the Championship Stewards and/or the Motorsport UK/MSK.

SR.6.1 RACE ORGANISING CLUBS AND M7RC CONTACTS:

| ORGANISERS / PROMOTERS | | | |
|---------------------------------------------------------------------------------------------------------------------------------------------------------------------------------------------------------------------------------------------------------------------------------------------------------------------------------------|------------------------------------------------------------------------------------------------------------------------------------------------------------------------------------------------------------------------------------------------------|-------------------------------------------------------------------------------------------------------------------------------------------------------------------------------------------------------------------------------------------------------------------------------------------------------------------------------------------------------------|----------------------------------------------------------------------------------------------------------------------------------------------------------------------------------------------------------------------------------------------------------------------------------------------------------------------------------------|
| M7RC Decals / Merchandise / Trophies/ Cam orders Mike Jackson 345 Clay Lane, South Yardley Birmingham, B26 1ES Tel: 0121 707 5881 Email: mike.jackson@mini7.co.uk www.mini7.co.uk Commercial Manager Colin Peacock Email: colin.peacock@mini7.co.uk | Championship Co-ordinator / Pitlane Review Editor / Archives/ Pit & Paddock Newsletter Richard Williamson 17 Hunters Tor Drive, Hookhills, Paignton, Devon, TQ4 7SG Tel: 07814 790060 E: richard.williamson@mini7.co.uk | Chairman Nick Cooke Email: nick.cooke@mini7.co.uk Drivers' Reps Mini Miglia – Mark Sims Email: mark.sims@mini7.co.uk Mini Se7en – Darren Thomas Email: darren.thomas@mini7.co.uk Mini-7 S-Class – Arnold Duncan Email: arnold.duncan@mini7.co.uk Mini Libre – Phil Harvey Email: phil.harvey@mini7.co.uk | Membership Barry Payne 52 Staplehurst, Wooden Hill, Bracknell, Berks, RG12 8DB, UK Email: membership@mini7.co.uk www.mini7.co.uk Technical Sub-Committee Phil Harvey Email: phil.harvey@mini7.co.uk Mark Wanstall Email: rightline@btinternet.com |

| CHAMPIONSHIP SERVICES / SPONSORS | | | |
|---------------------------------------------------------------------------------------------------------------------------------------------------------------------------------------------------------------------------------------------------------------------------------------------------------------------------------------------|--------------------------------------------------------------------------------------------------------------------------------------------------------------------------------------------------------------------------------------------------------------------------------------------------|----------------------------------------------------------------------------------------------------------------------------------------------------------------------------------------------------------------------------------------------------------------------------------------------------------------------------------------------------------------------------------------------|----------------------------------------------------------------------------------------------------------------------------------------------------------------------------------------------------------------------------------------------------------------------------------------------|
| Press Services / M7RC Website Stephen Colbran Tel: 07719 916929 Email: info@stephencolbran.co.uk www.mini7.co.uk Photography Matt Barrington Email: matthew-barrington@hotmail.co.uk mbracephotography.co.uk | Motorsport UK Eligibility Scrutineer Julian Affleck Email: julianaffleck@hotmail.com Motorsport UK Technical Commissioner Roger Ratley Email: rogerratley@gmail.com | Title Sponsor Dunlop Motorsport Michael Butler Tel: 0121 378 7000 www.dunlop.eu UK Tyre Supplier (Dunlop) HP Tyres Ltd Units 5&6 Broad March Trade Park Long March Industrial Estate Daventry, Northants, NN11 4HE Tel: 01327 301887 Email: office@hptyres.com | Title Co-Sponsor Mini Spares Roland Eckert c/o Unit 12+13 Cranbourne Ind. Estate Cranbourne Road, Potters Bar, Herts, EN6 3JN Tel: 01707 607700 Email: sales@minispares.com www.minispares.com |
| Shock Absorbers Spax Tel: 01869 244771 Email: info@spaxperformance.com www.spaxperformance.com Öhlins BG Motorsport Tel: 01327 855200 Email: info@bgmotorsport.co.uk www.bgmotorsport.co.uk | S-Class Manifolds & Exhausts Manifold Tel: 01722 335378 Email: manifold@lineone.net www.manifold.co.uk Camshafts Piper Cams Tel: 01303 245300 www.pipercams.co.uk | Mini Se7en Wheels Minilite [tech Dell] Tel: 01952 620215 Email: bev.minilite@virgin.net Mini Spares Tel: 01707 607700 Email: sales@minispares.com www.minispares.com Miglia LSD/Diffs www.quaife.co.uk www.swiftune.co.uk | Safeguarding Officer Amanda Proctor 22 Farley Dell Coleford, Somerset, BA3 5PJ Tel: 07773-010174 Email: amandaproctor0510@hotmail.co.uk Race Control-to-Driver Comms Race Receiver UK Bob Dunn Tel: 07811161616 Email: ukhire@btinternet.com |

| RACE ORGANISERS | | | |
|-------------------------------------------------------------------------------------------------------------------------------------------------------------------------------|-----------------------------------------------------------------------------------------------------------------------------------------------------------------------------------------------------------------------------------------------|--------------------------------------------------------------------------------------------------------------------------------------------------------------------------------------------------|----------------------------------------------------------------------------------------------------------------------------------------------------------------------------------------------------------|
| BRDC Silverstone Circuit Silverstone, nr Towcester Northants, NN12 8TN Tel: 01327 320269 www.brdc.co.uk | ECP Exploitatie Circuit Park Zandvoort BV Postbus 132, 2040 AC, Zandvoort Netherlands Tel: +31 61 81 45621 Email: menno@circuitzandvoort.nl www.cmcircuitzandvoort.nl | BARC Thruxton Circuit Andover, Hants SP11 8PN Tel: 01264 882200 Email: info@barc.net www.barc.net | NAT. SPORTING AUTHORITY Motorsport UK Bicester Motion Launton, Bicester, Oxon, OX27 8FY Tel: 01235 555552 www.motorsportuk.org |
| CCRC Castle Combe Circuit Castle Combe, Chippenham Wilts, SN14 7EY Tel: 01249 782417 www.ccracingclub.co.uk | MSV R (MotorSport Vision Racing) Brands Hatch, Fawkham Longfield, Kent, DA3 8NG Tel: 01474 875263 www.msvracing.com | BRSCC Building 60 Suite 1 Churchill Square Business Centre Kings Hill, West Malling Kent, ME19 4YU Tel: 01732 780100 www.brsc.co.uk | MGCC Kimber House 12 Cemetery Road Abingdon, Oxfordshire, OX14 1AS Tel: 01235 555552 Email: webmaster@mgcc.co.uk www.mgcc.co.uk |

SR.6.2 COMMERCIAL UNDERTAKINGS:

SR.6.2.1 INTRODUCTION:

SR.6.2.1.1 The following Commercial Regulations are 'contractual' between the Entrant and/or Driver and the Organisers and/or Promoters and are not considered by the Motorsport UK. Accordingly the application of these Commercial Regulations by the Organisers and/or Promoters will not be subject to the Judicial processes of either the Championship Stewards and/or the Motorsport UK / MSC. Registration for and entry into the Championship is conditional upon the Competitor meeting these conditions. A breach of any of the Commercial Undertakings may render the Competitor ineligible for competition and participation in this Championship entirely at the discretion of the Championship Organisers and/or Promoters. The onus will be on the Competitor to ensure that all persons connected with their team are aware of and comply with the requirements of the Commercial Undertakings

SR.6.2.1.2 Acceptance of a registration is at the absolute discretion of the Championship Organisers. Competitors must meet the standards and requirements of the Championship Organisers in respect of previous competition records. A refund either in part or full of the Series Entry Fee for any Competitor whose registration is accepted but who fails to participate in all or any of the rounds of the Championship is entirely at the discretion of the Championship Organisers and will only be considered in exceptional circumstances.

SR.6.2.1.3 The Championship Organisers reserve the right to add or vary the Commercial Undertakings at their sole discretion in the interests of promoting the Championship. Such additions or variations will be notified to Competitors via an Official Championship Bulletin.

SR.6.2.2 PADDOCK ARRANGEMENTS:

SR.6.2.2.1 The Paddock areas are intended to be working areas for the preparation of race cars. Space will be extremely limited and the Series Organisers/Promoters will liaise with Race Organisers for parking up to ensure the Paddock areas are used effectively. Competitors must follow the instructions contained in the general meeting Paddock plans issued by the Race Organisers and any detailed Paddock plans issued by the Championship Organisers/Promoters and must comply at all times with the instructions of the staff organising the parking up.

SR.6.2.2.2 Detailed information regarding the dimensions of team vehicles may be required by the Championship Organisers/Promoters and they reserve the right to check these dimensions at any other time

SR.6.2.2.3 Paddock space will be allocated to race car transporters but the admittance of any other team vehicles to the Paddock will only be allowed with the express permission of the Series Organisers/Promoters and only if space allows. In particular other areas outside the Paddock will normally be specified for the parking of team motor homes and private cars

SR.6.2.2.4 The space allocated to a team in the Paddock is strictly for the preparation of race cars. It is expressly forbidden to use this space as a hospitality or trade site area

SR.6.2.2.5 There will be a speed limit of 10mph in the Paddock at each venue. The only permitted movement of race cars within the Paddock is on the way to and from Scrutineering, to the Assembly Area and on the way back from *Parc Fermé* unless specifically requested by the meeting or Championship Organisers. At such times the car must be under the control of a holder of a full road traffic licence seated in the Driver's position. Any motorised team vehicles (including Quad bikes) must only be used by persons holding the appropriate UK driving licence, must keep to circuit roadways and be used only on official race team business. Recreational use is forbidden.

SR.6.2.2.6 Competitors may be issued with specific times to park up their Race Transporters in the Paddock at each meeting. Arrival outside the set periods is allowed only with the specific approval of the Championship Co-ordinator/Organisers

SR.6.2.2.6 Tailgates on transporters must remain closed unless cars/equipment are being loaded/unloaded. They must not be left open across circuit roadways

SR.6.2.2.7 Detailed Health and Safety Guidance Notes will be issued to Competitors in advance of the first meeting. These must be complied with at all times

SR.6.2.3 HOSPITALITY:

SR.6.2.3.1 Hospitality entertaining by way of any form of food/drink is strictly prohibited in Paddock areas

SR.6.2.3.2 Each team is permitted to provide general catering for team staff/drivers/family members only, up to a figure no greater than the number of personnel passes issued by the Series Organisers/Promoters to the team in respect of their entered car(s). Such catering operations can only be conducted in Paddock areas using vehicles granted paddock access by the Series Promoters/Championship Organisers

SR.6.2.3.3 Hospitality areas are available at most meetings from the circuit operators, subject to availability, and arrangements must be made in advance with the circuit hospitality department and the appropriate fees paid

- SR.6.2.3.4 Penalty charges of up to £1000 (+VAT) plus a charge of £25 (+VAT) per head over and above the permissible head count found to be entertained by way of hospitality may be levied on any team found to be breaking the terms of Regulation SR.6.2.3. In such circumstances circuit operators may also take separate action.
- SR.6.2.4 MISCELLANEOUS:
- SR.6.2.4.1 Competitors are advised that, unless requested otherwise, their information will be stored in a computer retrieval system and may be used to promote the Championship and/or the Series.
- SR.6.2.4.2 The Championship Eligibility Scrutineer and/or their nominated deputy shall be given free and unrestricted access at all times and at any location in order to inspect or measure or impound any component fitted to any car registered in the Championship.
- SR.6.2.4.3 If any round is scheduled to be a race at dusk or beyond, competitors will be expected to have the following light system functioning at all times during Practice, Qualifying Practice and Races:
Two forward-facing white headlights, two rear-facing red tail lights, and two rear-facing red brake lights. In addition the two side-door competition numbers must be lit in order for the numbers to be visible to officials and spectators. Teams may add additional low-power lighting for the purpose of identifying their cars at night, providing that these lights do not show red light to the front or white light to the rear of the vehicle or flash / strobe in any way.
Further clarification on the lighting required may be issued in an Official Championship Bulletin prior to the event.
- SR.6.3 TRADE SUPPORT VEHICLE DECALS & OVERALL PATCHES:**
- SR.6.3.1 No tobacco (or associated products) related advertising is permitted in any form in this Championship. Additionally, the display of any names or logos of any products that it is forbidden to advertise on European Union terrestrial TV stations is also prohibited.
- SR.6.3.2 No advertising or statements on the race car or Drivers' race clothing is permitted to conflict with the Championship Sponsors without written approval of the Challenge Organisers. Therefore, no racing cars to carry decals and/or logos of competitors to Dunlop, Mini Spares, Piper Cams, Spax, Öhlins (i.e. AVO, etc), unless agreed in writing.
- SR.6.3.3 No advertising or statements on the car, or team vehicles, or on Drivers' race clothing or team clothing is allowed which may reasonably be considered unsuitable or offensive to the Organiser/Promoters, or their Sponsors.
- SR.6.3.4 All cars must carry the Championship Sponsors' livery and paint/decals requirements in the correct locations, without alteration and without interference.
- SR.6.3.5 Competitors' own race car livery must meet the standards reasonably required by the Championship Organisers/Promoters having regard to the existing standards and prestige of the Championship.
- SR.6.3.6 The Championship Organisers reserve the right to refuse entry to the Championship and/or forbid participation or to pay Prize Monies/Bonus Awards if the livery does not meet the standards in TR.5.17.4.1 – TR.5.17.5.
- SR.6.3.7 At the start of each Event, Practice, Qualifying practice or Race, the cars (including the teams vehicles which are in the paddock) must be clean, smart and in good order. The Organisers reserve the right to forbid cars not meeting this requirement from taking part or remove them from the paddock.
- SR.6.4 PROMOTIONAL ACTIVITIES:**
- SR.6.4.1 All Drivers required for Podium Presentations should attend without delay, at the place and time specified by the Championship Co-ordinator or Organisers/Promoters. Sponsors Caps as determined by the Championship Organisers/Promoters must be worn on the driver's head. Failure to do so may mean forfeiting any Championship Prize Monies / Awards or Points gained at that round. Race drivers should be prepared to be wearing race overalls
- SR.6.4.2 Drivers must attend the end-of-season Awards Ceremony in order to claim their awards formally. Non-attendance may mean forfeiture of awards and / or Prize Monies unless previously agreed with the promoters
- SR.6.4.3 On occasions, cars and their race drivers may be required/invited to take part in promotional photo shoots, demonstrations, grid displays, etc, on behalf of the Challenge Organisers, Sponsors, Race Organisers, and other Promoters. At all times, cars should be presented in clean and tidy condition, and race drivers should be prepared to be dressed in race overalls and have their crash helmets with them.

MINI SE7EN**National Championships**

| | | | |
|------|----------------|------|----------------|
| 1966 | Bob Fox | 2000 | Dave Braggins |
| 1967 | Bob Fox | 2001 | Tim Sims* |
| 1968 | Mick Osborne | 2002 | Tim Sims |
| 1969 | Paul Gaymer | 2003 | Tim Sims |
| 1970 | Len Brammer | 2004 | James Hall |
| 1971 | Graham Wenham | 2005 | Paul Thompson |
| 1972 | Reg Armstrong | 2006 | Andrew Deviny |
| 1973 | Mick Moss | 2007 | Max Hunter |
| 1974 | Chris Tyrrell | 2008 | Paul Thompson |
| 1975 | Graham Wenham | 2009 | Kane Astin |
| 1976 | Graham Wenham | 2010 | Paul Spark |
| 1977 | Martin Goodall | 2011 | Paul Spark |
| 1978 | Steve Hall | 2012 | Paul Spark |
| 1979 | Patrick Watts | 2013 | Andrew Deviny |
| 1980 | Jonathan Lewis | 2014 | Andrew Deviny |
| 1981 | Gary Hall | 2015 | Paul Spark |
| 1982 | Gerald Dale | 2016 | Ashley Davies |
| 1983 | Chris Gould | 2017 | Charlie Budd |
| 1984 | Chris Gould | 2018 | Max Hunter |
| 1985 | Russell Grady | 2019 | Jeff Smith |
| 1986 | Chris Tyrrell | 2020 | Jeff Smith |
| 1987 | Chris Tyrrell | 2021 | Jeff Smith |
| 1988 | Malcolm Joyce | 2022 | Connor O'Brien |
| 1989 | Steve Cooper* | | |
| 1990 | Bill Sollis* | | |
| 1991 | Bill Sollis* | | |
| 1992 | Mike Jackson* | | |
| 1993 | Tina Cooper* | | |
| 1994 | Ian Curley | | |
| 1995 | Mike Jackson* | | |
| 1996 | Phil Manser* | | |
| 1997 | Steve Bell | | |
| 1998 | Matthew Hayman | | |
| 1999 | Dave Braggins | | |

**Overall Champion Award:
To the Mini Se7en or Mini
Miglia Champion who has
the highest end of season
points score. Award was a
Mini Cooper.*

MINI-7**S-CLASS****National Championships**

| | |
|------|-------------------|
| 2006 | Tristen Knight |
| 2007 | Nathan Burge |
| 2008 | Nathan Burge |
| 2009 | Julian Affleck |
| 2010 | Julian Affleck |
| 2011 | Julian Affleck |
| 2012 | Julian Proctor |
| 2013 | Julian Proctor |
| 2014 | Shaun Tarlton |
| 2015 | Ian Deviny |
| 2016 | Josh Collins |
| 2017 | Shaun Tarlton |
| 2018 | Scott Kendall |
| 2019 | Scott Kendall |
| 2020 | Connor O'Brien |
| 2021 | Michael Winkworth |
| 2022 | Damien Harrington |

MINI 1275 GT**National Championships**

| | |
|------|------------------|
| 1976 | Roger Saunders |
| 1977 | Steve Soper |
| 1978 | Jeremy Hampshire |
| 1979 | Steve Soper |
| 1980 | Steve Harris |

MINI MIGLIA**National Championships**

| | |
|------|-----------------|
| 2000 | Peter Baldwin* |
| 2001 | Peter Baldwin |
| 2002 | Chris Lewis |
| 2003 | Peter Baldwin |
| 2004 | Peter Baldwin |
| 2005 | Peter Baldwin |
| 2006 | Bill Sollis |
| 2007 | Andrew Hack |
| 2008 | Andrew Hack |
| 2009 | Andrew Hack |
| 2010 | Paul Thompson |
| 2011 | Endaf Owens |
| 2012 | Peter Baldwin |
| 2013 | Peter Baldwin |
| 2014 | Rupert Deeth |
| 2015 | Kane Astin |
| 2016 | Shayne Deegan |
| 2017 | Rupert Deeth |
| 2018 | Aaron Smith |
| 2019 | Aaron Smith |
| 2020 | Aaron Smith |
| 2021 | Andrew Jordan |
| 2022 | Rupert Deeth |
| 1970 | Mick Osborne |
| 1971 | Len Brammer |
| 1972 | Mick Osborne |
| 1973 | Phil Spurling |
| 1974 | Russell Dell |
| 1975 | Alan Curnow |
| 1976 | Mike Curnow |
| 1977 | Paul Gaymer |
| 1978 | Phil Spurling |
| 1979 | Phil Spurling |
| 1980 | Roland Nix |
| 1981 | Chris Hampshire |
| 1982 | Chris Lewis |
| 1983 | Chris Lewis |
| 1984 | Mike Fry |
| 1985 | Mike Fry |
| 1986 | Russell Grady |
| 1987 | Russell Grady |
| 1988 | Russell Grady |
| 1989 | Myk Cable |
| 1990 | Owen Hall |
| 1991 | Myk Cable |
| 1992 | Myk Cable |
| 1993 | Ian Gunn |
| 1994 | Chris Lewis* |
| 1995 | Chris Lewis |
| 1996 | Stewart Drake |
| 1997 | Bill Sollis* |
| 1998 | Ian Curley* |
| 1999 | Ian Curley* |

**Overall Champion Award:
To the Mini Se7en or Mini
Miglia Champion who has
the highest end of season
points score. Award was a
Mini Cooper.*

MINI MIGLIA**S-CLASS****National Championships**

| | |
|------|-------------|
| 2006 | Phil Harvey |
| 2007 | Phil Harvey |
| 2008 | Phil Harvey |
| 2016 | Jim Burrows |
| 2017 | Jim Burrows |

MINI LIBRE**Invitational trophy**

| | |
|------|-----------------|
| 2017 | Peter Crewes |
| 2018 | Phil Harvey |
| 2019 | Phil Harvey |
| 2020 | Dan Lewis |
| 2021 | Peter Crewes |
| 2022 | Richard Colburn |

SPECIAL EVENTS**50-Plate**

2015 S Deegan / A Davies

0-Plate

| | |
|------|----------------------|
| 2017 | L Deegan / L Window |
| 2018 | R Deeth / L Wightman |
| 2019 | C Peacock / J Smith |
| 2021 | R Deeth / A Jordan |
| 2022 | J Smith / C O'Brien |

MINI SE7EN

Winter / Southern Series

| | |
|------|----------------------------------|
| 1971 | Mick Collard |
| 1972 | David Sambell |
| 1973 | Geoff Gilkes |
| 1974 | Geoff Gilkes |
| 1975 | Graham Wenham |
| 1976 | Bob Addison |
| 1977 | Richard Hamlyn |
| 1978 | Jim McDougall |
| 1979 | Roy Finlay |
| 1980 | Gerald Dale |
| 1981 | Richard Hamlyn |
| 1982 | Chris Gould |
| 1983 | Chris Gould |
| 1984 | Chris Gould |
| 1985 | Steve Mole |
| 1986 | Bill Sollis |
| 1987 | Bill Sollis |
| 1988 | Guy Sims |
| 1989 | – |
| 1990 | Alan Rogers |
| 1991 | Kelly Rogers |
| 1992 | Kelly Rogers |
| 1993 | Ian Curley |
| 1994 | Kelly Rogers + Matthew Hayman |
| 1995 | Dave Braggins |
| 1996 | James Hayman |
| 1997 | Alan Waite |
| 1998 | Dave Banwell |
| 1999 | Ian Deviny |
| 2000 | Andrew Deviny |
| 2001 | James Winnifrith |
| 2002 | Andy Hack |
| 2003 | Nick Tandy |
| 2019 | Jeff Smith |
| 2020 | – |
| 2021 | Jeff Smith |
| 2022 | Connor O'Brien |

Novices Award

| | |
|------|--------------------------------|
| 1973 | Hugo Shipley |
| 1974 | John West |
| 1975 | Jeremy Wheatley |
| 1976 | Chris Lewis |
| 1977 | Tristan Batch |
| 1978 | Rob Selby |
| 1979 | Jonathan Lewis |
| 1980 | Derek Miller + Peter Lawton |
| 1981 | Mark Cinnamon |
| 1982 | Barbara Cowell |
| 1983 | Jeremy Omerod |
| 1984 | Dave Banwell |
| 1985 | Bill Sollis |
| 1986 | Alan Jackson |
| 1987 | Steve Cooper |
| 1988 | Andy Hack |
| 1989 | Bill Boyle |
| 1990 | Niven Burge |
| 1991 | Tim Stanbridge |
| 1992 | Shaun King |
| 1993 | Matthew Hayman |
| 1994 | John Pearson |
| 1995 | James Hayman |
| 1996 | Paul Woodbridge |
| 1997 | Sarah Munns |
| 1998 | Tom Francis |
| 1999 | Peter Weston |
| 2000 | Duncan Emmett |
| 2001 | James Loukes |
| 2002 | Max Hunter |
| 2003 | Lewis Selby |
| 2004 | Alex Myall |
| 2005 | Lee Jones |
| 2006 | Ricky Horne |
| 2007 | Thomas Knight |
| 2008 | Neil Robins |
| 2009 | Terry Barringer |
| 2010 | Mike Rayner |
| 2011 | Ashley Davies |
| 2012 | Ross Billison |
| 2013 | Justin Drury |
| 2014 | Shaun Tarlton |
| 2015 | Lewis Fox |
| 2016 | Leon Oli Window |
| 2017 | Joe Thompson |
| 2018 | Stephen Colbran |
| 2019 | Glen Woodbridge |
| 2020 | Jordan Sims |
| 2021 | Chris Didcott |
| 2022 | Andy King |

MINI MIGLIA

Winter / Southern Series

| | |
|------|----------------|
| 1979 | Paul Rowland |
| 1980 | John Meale |
| 1981 | John Meale |
| 1982 | Jim McDougall |
| 1983 | Peter Moore |
| 1984 | Mike Fry |
| 1985 | Gerald Dale |
| 1986 | Mark Jones |
| 1987 | Mark Jones |
| 1988 | Mark Jones |
| 1989 | – |
| 1990 | Tony Parker |
| 1991 | Tony Parker |
| 1992 | Chris Lewis |
| 1993 | Jonathan Lee |
| 1994 | Dave Hancock |
| 1995 | Peter Baldwin |
| 1996 | Wayne Grayer |
| 1997 | Tony Higgins |
| 1998 | David Abbott |
| 1999 | Jonathan Lewis |
| 2000 | Kevin Mason |
| 2001 | Kelly Rogers |
| 2002 | Paul Brown |
| 2003 | Martin Wager |
| 2019 | Colin Peacock |
| 2020 | – |
| 2021 | Endaf Owens |
| 2022 | Rupert Deeth |

Novices Award

| | |
|------|----------------------------------|
| 1973 | Kelvin May |
| 1974 | Gary Cashman |
| 1975 | Colin Davies |
| 1976 | Bryan Dugdale |
| 1977 | Peter Calver |
| 1978 | Paul Earley |
| 1979 | Keith Vinycomb |
| 1980 | Bryan Slark + Marco Del Pizzo |
| 1981 | Gordon Pocock |
| 1982 | Miles Johnston |
| 1983 | Brian Quinn |
| 1984 | Grant Munday |
| 1985 | Mark Jones |
| 1986 | Richard Collins |
| 1987 | Owen Hall |
| 1988 | Steve Holtom |
| 1989 | Eamonn Moran |
| 1990 | Bob Pearson |
| 1991 | Jonathan Lee |
| 1992 | Steve Blunt |
| 1993 | Jonathan Lloyd |
| 1994 | Nick Reynolds |
| 1995 | David Lawrence |
| 1996 | David McGuinness |
| 1997 | Tony Higgins |
| 1998 | Endaf Owens |
| 1999 | Stephen Dalby |
| 2000 | Adrian Young |
| 2001 | Andrew Howard |
| 2002 | Paul Simmonds |
| 2003 | – |
| 2004 | Phil Anning |
| 2005 | Keith Allington |
| 2006 | Paul Baird |
| 2007 | Andrew Worsley |
| 2008 | Owen Stinchcombe |
| 2009 | Dave Drew |
| 2010 | Mark Cowan |
| 2011 | – |
| 2012 | Iain Cameron |
| 2013 | – |
| 2014 | – |
| 2015 | Ian Briscall |
| 2016 | – |
| 2017 | Alfie Brown |
| 2018 | Richard Jessop |
| 2019 | Stuart Wright |
| 2020 | Jason Balding |
| 2021 | Darren Mason |
| 2022 | - |

MINI-7 S-CLASS

Winter Series

| | |
|------|-------------------|
| 2019 | Connor O'Brien |
| 2020 | – |
| 2021 | Ryan Taylor |
| 2022 | Michael Winkworth |

Novices Award

| | |
|------|-------------|
| 2019 | Ben Cutler |
| 2020 | Matt Ayres |
| 2021 | Ryan Taylor |
| 2022 | Frazer Hack |

MINI SE7EN

Graham Hill Memorial Trophy

1977 Steve Hall
1978 Roy Finlay
1979 Tim Lester
1980 Gordon Levett
1981 Steve Mole
2018 Thorburn Astin (under-17 S-Class)
2019 Ben Cutler (under-17 S-Class)
2020 Ryan Taylor (under-17 S-Class)
2021 Ryan Taylor (under-17 S-Class)
2022 Ollie Handley (under-17 S-Class)

Cadwell Park Championship

1978 Chris Tyrrell (overall)

Lydden Championship

1983 Barbara Cowell
1984 Chris Gould
1985 Peter Kavanagh
1986 Chris Tyrrell
1987 Bill Sollis
1988 Bill Sollis

MINI MIGLIA

Graham Hill Memorial Trophy

1977 Peter Hill
1978 Ken Brown
1979 Tony Edmonds
1980 John Simpson
1981 Stewart Fowler

Castle Combe Championship

1983 Mike Fry (overall)

Lydden Championship

1983 Peter Moore
1984 David Titmuss
1985 Grant Munday
1986 Bev Comber
1987 Bev Comber
1988 Mark Jones

SR6.6: SEALING REFERENCE / IMAGES (refer also to SR.3.2.1 and TR.5.4.3)

- Three (x3) adjacent cylinder head studs (see image 'Sealing 1').
- Two (x2) rocker cover fixings (image 'Sealing 2').
- Two (x2) adjacent flywheel bellhousing/cover bolts (image 'Sealing 3')... OR, note white line across bellhousing/cover (image 'Sealing 4'); this may be drilled straight through both sections as an alternative.
- Two (x2) adjacent timing cover bolts for chain drive, or equivalent gear drive (image 'Sealing 5'), or a pair of two (x2) drilled holes (x4 in total), to allow for sealing wire on opposing edges of equivalent belt drive cover (image 'Sealing 10')... OR, if belt drive without timing cover is fitted, provision must be made for the large camshaft end nut to be marked with scrutineering sealing paint (image 'Sealing 6').
- One (x1) manifold/carburettor stud, drilled at both ends to allow sealing wire to pass through both holes (image 'Sealing 7').
- Two (x2) adjacent diff housing bolts (image 'Sealing 8').
- Two (x2) adjacent speedo drive housing/gearbox end casing bolts (image 'Sealing 9').
- The drilled holes should be 2mm diameter minimum.

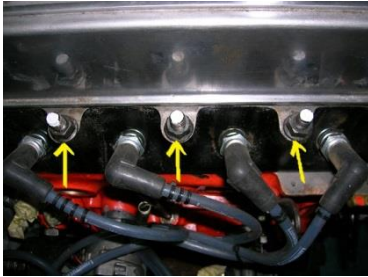

**'Sealing 1' –
Cylinder head**



**'Sealing 2' –
Rocker cover**

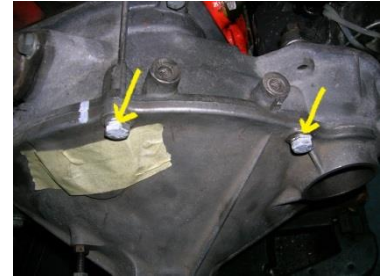

**'Sealing 3' –
Flywheel / Bellhousing... or**



**'Sealing 4' –
...flywheel / bellhousing**

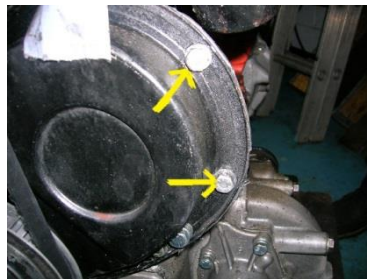

**'Sealing 5' –
Timing cover, chain/gear drive**



**'Sealing 6' –
Camshaft end nut**

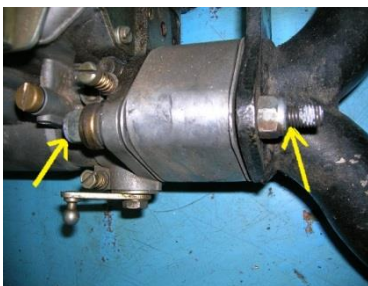

**'Sealing 7' –
Manifold / Carburettor**

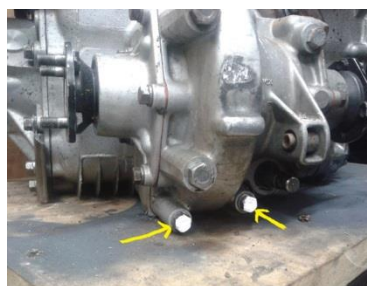

**'Sealing 8' –
Diff housing**



**'Sealing 9' –
Speedo drive/Gearbox end casing**



**'Sealing 10' –
Timing cover, belt drive**



A socially-minded standard of behaviour is expected from everyone within the motorsport community.

By participating in a Motorsport UK event in any capacity you agree to follow the values of the Respect Code:

Motorsportuk.org/racewithrespect
#RaceWithRespect

The Values

- Respect
- Fair play
- Integrity
- Good Manners
- Self-Control

I pledge to #RaceWithRespect and:

- Contribute to a welcoming and friendly environment that ensures the safety and welfare of all participants.
- Always behave with integrity and uphold fairness in the sport; play your part in keeping the sport safe through your actions
- Treat everyone with respect, regardless of their gender, ethnic or social background, language, religious or other beliefs, disability, sexual identity or other status
- Recognise that we all represent the sport and therefore have a duty to be polite and respectful to all staff, officials, fellow competitors, volunteers, as well as fans and supporters
- Respect the rules, regulations and authority of the officials and Motorsport UK

Any breach of these obligations may result in disciplinary action.