

Mazda MX-5 Championship and Clubman 2025 Supplementary Technical File

Table of Contents

1.	General Engine.....	3
2.	Seals.....	3
3.	Cylinder Head.....	3
3.1	Cam Cover.....	3
3.2	Cylinder Head	4
3.3	Head skim.....	4
3.4	Valves and Valve Seats.....	4
3.5	Valve Springs.....	5
3.6	Valve Spring Seats.....	5
3.7	Valve Guides.....	5
3.8	Hydraulic Lifters	5
4.	Cams.....	5
4.1	Cam Pulleys.....	6
4.2	Cam Timing.....	6
4.3	Ignition Timing.....	7
5.	Spark Plugs and Ignition Leads.....	8
6.	Induction (Intake and Intake Manifold)	8
6.1	Airbox and air filter	8
6.2	Air intake pipe.....	8
6.3	Induction pipe.....	9
6.4	Air Flow Meter	9
6.5	Throttle Body, Idle Control Valve and Air Valve	10
6.6	Positive Crankcase Ventilation (PCV) and Evaporative Emission Control (EVAP) System	11
6.7	Fuel injectors, fuel pump, fuel pressure regulator and fuel lines	11
7.	Block/Pistons/Crank.....	11
7.1	Block.....	11
7.2	Pistons and Piston Rings	12
7.3	Connecting Rods	13
7.4	Crankshaft	14
7.5	Bearings.....	14
7.6	Oil Squirters/Jets.....	14
7.7	Oil Pan Baffle and Sump.....	14
7.8	Oil Pump	15
7.9	Water Pump.....	15
7.10	Front pulley.....	15
7.11	Flywheel.....	15
7.12	Clutch.....	16
8.	Thermostat and Cooling	16

DRAFT DRAFT DRAFT

8.1	Thermostat.....	16
8.2	Coolant Temperature Sensor (for the Electronic Control Unit (ECU)).....	16
8.3	Radiator.....	16
8.4	Oil Cooler.....	16
9.	Exhaust.....	16
9.1	Exhaust Manifold.....	16
9.2	Exhaust System (from the manifold back).....	17
10.	Engine Electronics.....	17
10.1	Engine Control Unit (ECU).....	17
10.2	Alternator.....	17
10.3	Wiring Harness.....	17

1. General Engine

The only permitted engine is the Mazda B6 Double Overhead Cam (DOHC) in-line 4 cylinder with a nominal displacement of 1600 cc.

The engine must be run on normal unleaded or super unleaded petrol. Only pump fuel as defined in Motorsport UK General Regulations Nomenclature and Definitions (see Pump Fuel) may be used. The use of power boosting or octane boosting additives in any fuel is prohibited. A minimum of 3 litres of fuel must remain in the fuel tank at the end of qualifying or race.

The engine location and orientation must remain as per the Mazda manufacturing location.

Engine mounts may be original Mazda or replaced with uprated competition parts (as long as they are the same dimensions). Solid engine mounts are not permitted.

2. Seals

Two adjacent cam cover bolts must be cross drilled (minimum 3 mm diameter) to accept Motorsport UK wire seals. The 2 bolts to be drilled must be the bolts highlighted in Image 1 (i.e. not the front 2 bolts).

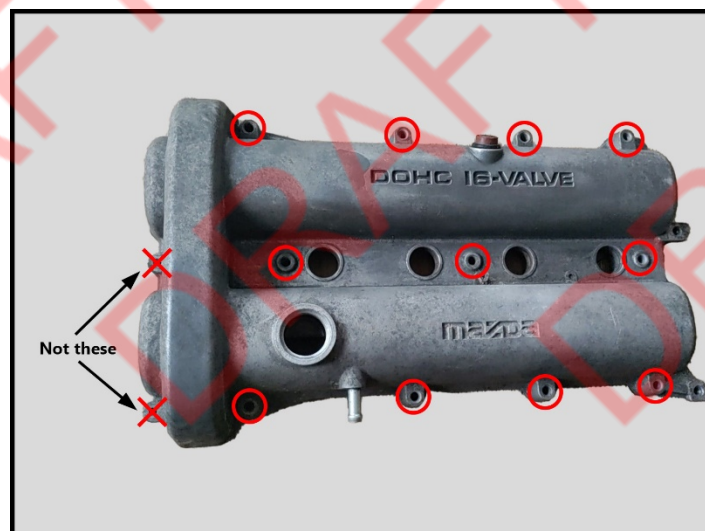

Image 1

3. Cylinder Head

3.1 Cam Cover

It is permitted to cut off the front section of the cam cover to enable viewing/access of the cam pulleys and cam belt (see Image 2).

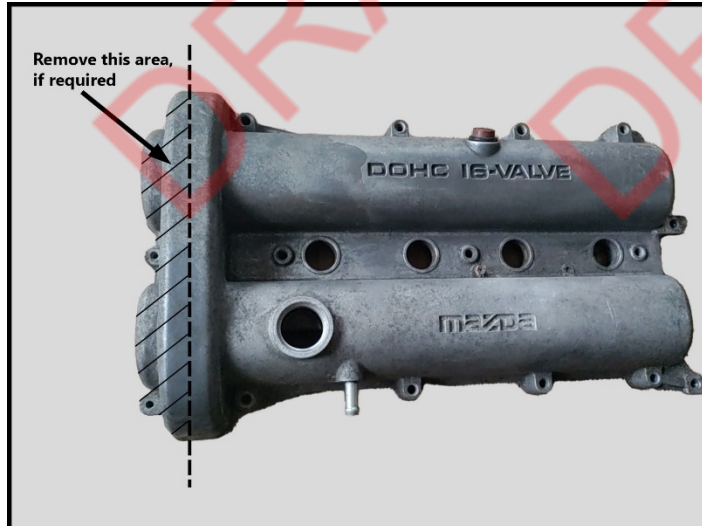

Image 2

It is permitted to remove the plastic cambelt covers from the front of the engine.

3.2 Cylinder Head

Porting or polishing of the inlet or exhaust ports of the cylinder head is prohibited.

It is not permitted to port, port match, machine or alter any part of the inlet manifold (for example to port match the inlet manifold ports to the cylinder head ports or match the throttle body to the inlet manifold).

Cylinder head gaskets (between the block and the head) are free. It is permitted to use a multi layer steel head gasket (e.g. Cometic). Cylinder head gasket thickness is free.

3.3 Head skim

Head skimming is free

3.4 Valves and Valve Seats

Valve specifications (all dimensions are millimetres unless otherwise stated) :

Valve head diameter	Inlet		30.9 – 31.1
	Exhaust		26.1 – 26.3
Valve face angle	Inlet		Free
	Exhaust		Free
Valve length	Inlet	Standard	105.29
		Minimum	104.79
	Exhaust	Standard	105.39
		Minimum	104.89

Valve stem diameter	Inlet		5.970 – 5.985
	Exhaust		5.965 – 5.980
Valve guide inner diameter			6.01 – 6.03

Valve seat (the seat is in the part in the cylinder head) angles are free.

It is permitted to use standard pattern inlet and exhaust valves provided that they meet the original form and dimensions.

3.5 Valve Springs

Free length	Inlet	Standard	48.0
		Minimum	47.0
	Exhaust	Standard	48.3
		Minimum	47.3
Setting Load/Height	Inlet		22.1 – 25.1 Kg @ 40 mm
	Exhaust		17.7 – 20 Kg @ 40 mm

3.6 Valve Spring Seats

There is a metal shim that sits underneath the valve spring (between the spring and the head). Only one of these shims is allowed. The thickness of the shim is 0.5 mm

3.7 Valve Guides

It is permitted to replace the valve guides with items of the same form and dimension. It is permitted to fit 'K-Line' valve guide liners to bring a worn valve guide back into specification.

3.8 Hydraulic Lifters

Standard Mazda hydraulic lifter must be used without modification. It is permitted to use the Kia hydraulic lifter of the same form and dimension.

4. Cams

It is only permitted to use standard Mazda camshafts. The part numbers are stamped on the cams : Inlet is B660 (Image 3) and Exhaust is B61P (Image 4).



Image 3



Image 4

It is not permitted to regrind, re-profile or modify the cams in anyway.

The permitted cam measurements across the cam lobe are shown in Image 5.

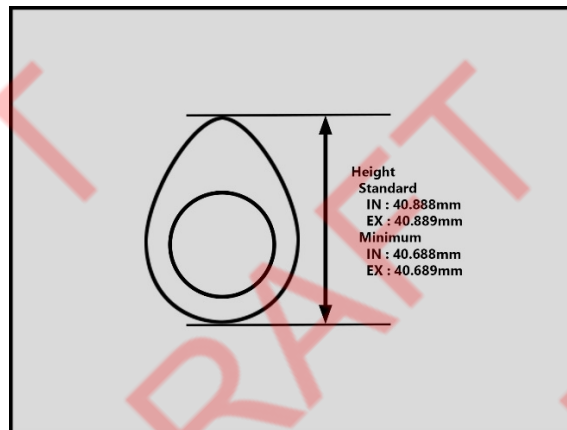

Image 5

4.1 Cam Pulleys

The use of vernier cam pulley wheels is prohibited.

The location of the dowels in the end of the camshafts to locate the pulleys must be in the original manufacturers location. No offsetting of the dowels is permitted.

The locating slots in the cam pulleys must not be modified.

4.2 Cam Timing

The manufacturer's standard cam timing must be maintained. With the number one piston (closest to the front of the car) at Top Dead Centre (TDC), the letters ('I' and 'E') and the timing marks on the pulleys must be at the top of the pulley, pointing vertically up. There must be 19 teeth counted on the cambelt between the vertical mark on the Inlet pulley and the vertical mark on the Exhaust pulley (Image 6).



Image 6

The water pump must not be modified to relocate the cambelt idler pulley to any location other than standard.

Any method that alters the manufacturers standard valve timing is prohibited.

4.3 Ignition Timing

It is permitted to adjust the camshaft position sensor (at the back of the engine, driven off the inlet cam).

The maximum permitted ignition advance is 15 degrees. This is measured with a strobe light and with a wire connected across the GND and TEN pins in the diagnostic port (Image 7). With the engine running, the engine speed adjusted to 1000 rpm and the strobe pointed at the front crank pulley, the TDC timing mark on the pulley can be compared to the timing marks on the plastic cam belt cover (Image 7). Please note that the TDC mark on the pulley must be checked to see if it lines up with the TDC mark on the plastic cam belt cover – this can be done by putting a dial gauge on the piston in cylinder one to determine an accurate TDC.

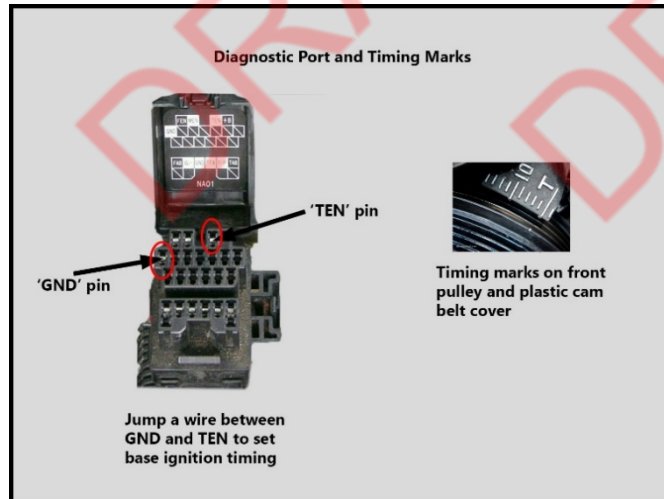

Image 7

The camshaft position sensor may not be altered physically or electronically in anyway.

5. Spark Plugs and Ignition Leads

The type and grade of spark plug is free provided that they are a direct replacement for the standard plug. A standard plug is listed as NGK BKR5E-11 or NGK BKR6E-11 or NGK BKR7E-11.

High tension ignition leads are free.

6. Induction (Intake and Intake Manifold)

6.1 Airbox and air filter

The standard airbox must be fitted without modification.

An air filter must be fitted and may be of the free flow type.

6.2 Air intake pipe

The cold air intake pipe to the standard airbox housing is free with a maximum internal diameter of 63 mm. The cold air pipe must be fitted to the air filter housing and be the sole source of air for the engine. This pipe must be the sole source of air to the air filter housing.

It is permitted to carry out minor modifications to the radiator mounting panel in order to allow installation of the cold air pipe which must collect air only from the grille area, and just behind the grille itself. There must be no holes through the grille (other than the grille itself) and the grille mesh must remain intact. A grille that fills the entirety of the front radiator aperture must be fitted but it may be non-standard.

Alternatively, a cold air intake, which utilises a NACA duct type intake may be fitted to the left headlamp cover. This unit must be the sole source of air to the air filter housing.

6.3 Induction pipe

It is not permitted to wrap any part of the induction pipe with heat reflecting material.

It is permitted to strengthen the concertina section of air pipe between the air flow meter and the throttle body but this must not alter the standard flow of air inside the system (Image 8). No other modification to the inlet pipe is permitted (e.g. blocking of internal airways to the resonance chamber).

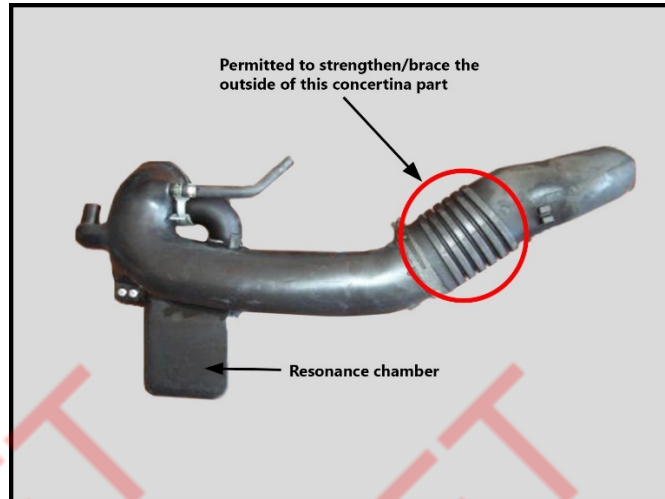

Image 8

6.4 Air Flow Meter

The standard Air Flow Meter must be fitted and remain mounted in its original location and orientation.

All air entering the engine must travel through the Air Flow Meter.

The pinout for the Air Flow Meter is as follows (Image 9) :-

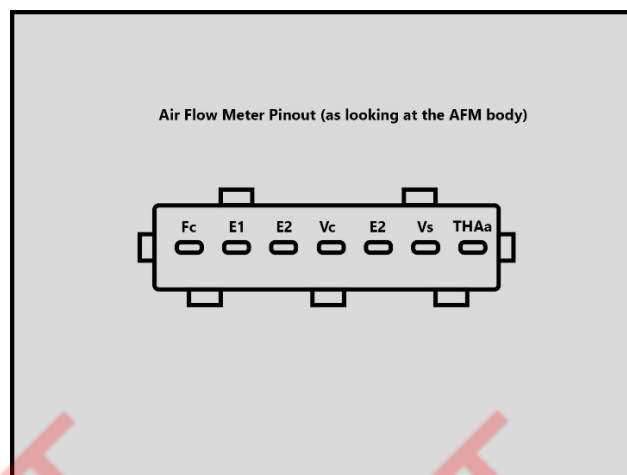

Image 9

The following specifications for the Air Flow Meter must be met :

Resistance between	E2 and Vs	Fully Closed	200 – 600 Ω
		Fully Open	20 – 1,000 Ω
	E2 and Vc		200 – 400 Ω
	E2 and THAa	-20°C	13,600 – 18,400 Ω
		20°C	2,210 – 2,690 Ω
		80°C	493 – 667 Ω
	E1 and Fc	Fully Closed	∞
		Fully Open	0

It is permitted to drill out the cap (Image 10) to uncover a screw which may be adjusted.

It is permitted to remove the top cover (Image 10) to allow access to the Air Flow Meter internals.

It is permitted to adjust the tension on the clock spring.



Image 10

It is not permitted to alter any of the electronic components in the Air Flow Meter.

With the engine switched off (i.e. no air flow through the Air Flow Meter), the fuel pump cut off 'arm' within the Air Flow Meter must engage with the contacts to ensure the fuel pump does not operate when the engine is off.

6.5 Throttle Body, Idle Control Valve and Air Valve

The standard throttle body must be used and not modified in any way. The internal diameter of the standard throttle body is 55 mm.

It is permitted to alter the coolant routing through the idle control valve and/or the air valve. However, it is not permitted to remove the idle control valve from the throttle body, or the air valve from the inlet manifold (see Image 11 for detail)

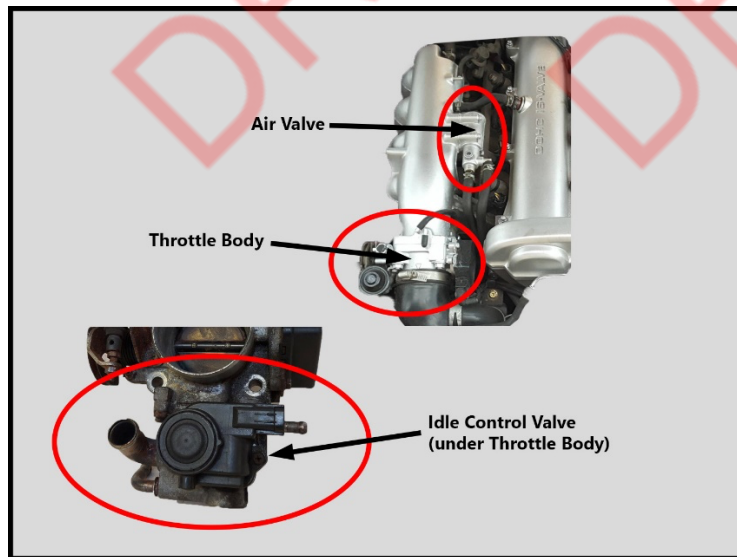

Image 11

6.6 Positive Crankcase Ventilation (PCV) and Evaporative Emission Control (EVAP) System

The standard PCV valve must be fitted in the cam cover and connected to the inlet manifold via an open pipe.

The charcoal canister, purge control solenoid and associated piping may be removed.

6.7 Fuel injectors, fuel pump, fuel pressure regulator and fuel lines

The fuel injectors ('blue top'), fuel rail and fuel regulator must be standard or standard pattern parts. The fuel pressure regulator operation must be as original.

Nominal flow rate for the standard 'blue top' injectors at 43.5 psi is 230 cc/minute.

Resistance of standard injectors is 12 – 16 Ω at around 20° C.

The maximum fuel pressure permitted at the injectors is 3.2 bar (46 psi)

It is permitted to fit a fuel take off valve and associated piping and a switch to enable draining of the fuel tank.

The fuel pump may be replaced with a standard pattern part. Standard fuel pump pressure is 64 – 85 psi.

It is permitted to replace the standard fuel piping as long as the replacement piping/tubing is rated for 85psi or more and is made for the transit of unleaded or super unleaded fuel.

7. Block/Pistons/Crank

7.1 Block

The standard Mazda B6 cast iron block must be used.

The height of a standard block (measured from the cylinder head gasket face to the sump mating face) is 221.5 mm. It is permitted to skim the top face of the block to a maximum of 0.20mm, thus making a minimum block height of 221.3 mm.

Standard bore size is 78.0 mm.

It is permitted to bore and/or hone the block cylinders to accept up to a 0.50 mm oversize piston.

It is permitted to re-line the block with new cylinder liners subject to pistons complying with 7.2

No other machining of the block is allowed.

7.2 Pistons and Piston Rings

It is permitted to use standard pattern replacement pistons and rings provided that they meet the original form and dimensions. The maximum oversize piston permitted is 0.50 mm.

Image 12 shows some sample images of standard Mazda pistons.



Image 12

The only permitted genuine Mazda pistons (9.4 compression ratio) are :

Size	Part Number
Standard size	B6Z2-11-SA0C
0.25 mm oversize	B6Z2-11-SB0C
0.50 mm oversize	B6Z2-11-SBXC

Permitted I.L. Motorsport pistons (9.4 compression ratio) are :

Size	Part Number
0.25 mm oversize	NA1-2015A
0.50 mm oversize	NA1-2016A

It is not permitted to use a piston that is not rated to a 9.4 compression ratio. For instance, it is not permitted to use Mazda part number B6Z4-11-SB0 which is a 0.25 mm oversize piston but with a 9.6 compression ratio.

Piston rings are free but must be of the same form and dimension as standard Mazda rings. It is not permitted to use 'Total Seal' or 'gapless' rings.

Gudgeon/wrist pins are free but must be of the same form and dimension as standard Mazda. No machining of the gudgeon/wrist pin is allowed.

It is permitted to 'balance' a set of pistons by machining or grinding. However one piston must remain unmarked and in its original, unmodified form (i.e. only three of the four pistons may be machined).

All piston rings must be installed – there must be a top ring, a second ring and 2 oil scraper rings sandwiching an oil scraper (Image 13).

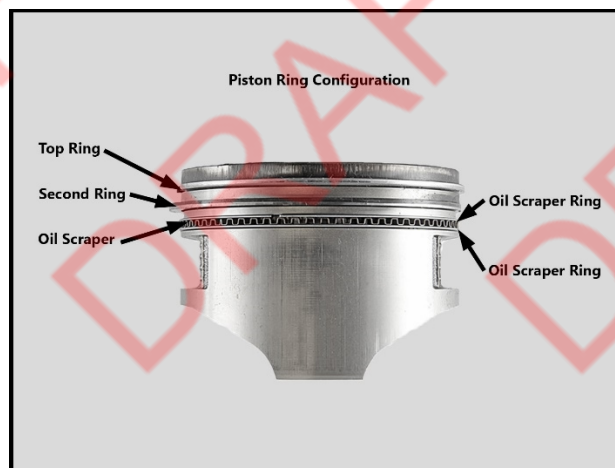

Image 13

It is not permitted to machine or grind the top surface of the piston, including the valve pockets already present from the original manufacturer. If there has been any contact between valves and pistons (e.g. during an 'over-rev'), then any damage caused to the top of the piston should be left alone and not further machined or ground and the piston should be replaced at the earliest opportunity.

7.3 Connecting Rods

Standard Mazda (part number B6S7-11-210D or B6S7-11-210E) or pattern parts with the same form and dimension must be used.

It is permitted to 'balance' a set of connecting rods by machining or grinding. However one connecting rod must remain unmarked (i.e. only three of the four connecting rods may be machined).

7.4 Crankshaft

A Mazda crankshaft must be used. This may be of the 'short nose' type (smaller diameter through the oil pump – part number B6S7-11-300) or 'long nose' type (larger diameter through the oil pump, typically year 1991 onwards – part number B6S7-11-300A).

The stroke of the crankshaft must be 83.6 mm.

It is not permitted to lighten the crank by machining or grinding away from standard form and dimension, unless the lightening is specifically for balancing the crankshaft with minimal material removed.

It is permitted to balance the crankshaft by minimal localised drilling and/or grinding. It is also permitted to add 'heavy metal' to the crankshaft to assist balancing.

It is permitted to grind the crankshaft main and/or big end bearings to accept undersize bearings up to 0.75 mm undersize. It is not permitted to change the stroke length if the crankshaft is reground to accept undersize bearings.

7.5 Bearings

Main bearings and connecting rod ('big end' and 'little end') bearings are free.

Thrust bearings are free.

It is permitted to use 'Race' designated bearings. It is permitted to mix and/or match different makes and/or types of bearings between the main bearings and connecting rod bearings.

Undersize bearings are permitted to a size of 0.75 mm.

7.6 Oil Squirters/Jets

Standard Mazda oil squirters/jets (i.e. both parts - the banjo bolt with the ball bearing and spring one way valve, and the squirter nozzle/jet) must be fitted and operating as designed.

It is not permitted to change the configuration or block the oil squirters/jets to disable oil squirting up onto the underside of the pistons as per Mazda design.

7.7 Oil Pan Baffle and Sump

It is not permitted to modify the Mazda standard oil pan baffle (sometimes called a windage tray) This is the 'gold coloured' tray that sits between the sump and the block. It is permitted to add extra baffles to the sump, or fit an 'anti-oil surge system' (such as the SkidNation Oil Pan Baffle kit) to the sump to prevent oil starvation under hard braking/cornering.

7.8 Oil Pump

Standard Mazda or pattern parts with the same form and dimension must be used.

It is permitted to replace the pump gears with uprated gears of a higher specification material (e.g. Boundary gears) or replace the whole pump with an uprated item (e.g. Boundary pump).

7.9 Water Pump

The water pump impeller is free as long as the main water pump housing is standard Mazda or a pattern part of the same form and dimension. This is to allow different impeller configurations from different manufacturers.

The water pump must not be modified to relocate the cambelt idler pulley to any location other than standard.

7.10 Front pulley

It is not permitted to modify the crankshaft front pulley. The only acceptable pulleys are the original Mazda supplied ones (Image 14) in either the '4 slot' (for fitting on the 'short nose' crankshaft – part number B6S7-11-401a) or the '8 slot' (for fitting on the 'long nose' crankshaft – part number B6S8-11-401).



Image 14

7.11 Flywheel

It is permitted to use any standard MX-5 flywheel that is/was available through the Mazda dealer network however the minimum weight of the flywheel excluding the clutch securing bolts is 7 kilograms (including the pilot bearing pressed into the centre of the flywheel)

7.12 Clutch

Clutch disk and pressure plate are free, providing they mount in the standard locations on the standard flywheel.

8. Thermostat and Cooling

8.1 Thermostat

Thermostats are free.

It is permitted to remove the thermostat.

8.2 Coolant Temperature Sensor (for the Electronic Control Unit (ECU))

The water thermosensor (back of engine) must be standard and have the following specification :

Resistance	-20° C	14.6 – 17.8 kΩ
	20° C	2.2 – 2.7 kΩ
	80° C	0.29 – 0.35 kΩ

8.3 Radiator

Radiators are free as long as the original mounting points are used. It is permitted to fit an aftermarket, high capacity, metal type radiator as long as the original mounting points are used.

8.4 Oil Cooler

It is permitted to fit an oil cooler take off plate, pipes and oil cooler radiator. All of the oil cooler system must be fitted in the engine compartment.

9. Exhaust

9.1 Exhaust Manifold

The standard exhaust manifold fitted with a standard or standard pattern operational oxygen/lambda sensor must be used.

It is permitted to remove material from inside of the exhaust manifold to a depth 10 mm to align the head to manifold ports. Should such removal result in weakness or leakage it is permitted to locally repair the area by the addition of material to the outside of the manifold only.

It is not permitted to heat wrap any part of the exhaust manifold.

The lower manifold mounting bracket should be retained to prevent cracking of the manifold.

9.2 Exhaust System (from the manifold back)

Exhausts are free to a maximum O.D of 60 mm and must comply with Motorsport UK Regulation [J 5.16] to [J 5.18] noise regulations. A catalytic converter may be fitted.

It is permitted to fit an exhaust embellisher to the tailpipe. This may be no more than 150mm long and must not act as an exhaust extractor.

The exhaust must exit in the standard position.

It is not permitted to heat wrap any part of the exhaust system.

10. Engine Electronics

10.1 Engine Control Unit (ECU)

Only one ECU that controls the engine can be fitted to the car. This may be relocated to the passenger side footwell.

The ECU must be a standard Mazda unit.

It is not permitted to modify the operation of the standard Mazda ECU by the alteration or fitment of components either internally or externally.

The standard clock frequency of the Mazda ECU is 4.00 MHz.

10.2 Alternator

The charging system must remain completely as standard, and the car must remain fitted with a standard or standard pattern fully operational alternator. It is not permitted to alter the alternator belt pulley size from standard.

A fully working standard alternator must be fitted and electrically connected so that the standard battery charging function is providing to the onboard battery at all times when the engine is running.

10.3 Wiring Harness

The vehicle wiring harness is free provided that it maintains the function of all of the required electrical systems and maintains them within the manufacturer's parameters.