



2026 PROTYRE MOTORSPORT GINETTA GT CHAMPIONSHIP

Sporting, Technical and Commercial Regulations



motor
sport
UK



A Motorsport UK recognised motor racing championship, registered by:

British Racing and Sports Car Club

PUBLISHED COPY

Signed: Kelly Robertson
Kelly Robertson (Apr 21, 2026 13:03:01 GMT+1)
KELLY ROBERTSON – CHAMPIONSHIP COORDINATOR

Date: 21/04/2026

CONTENTS

1	SPORTING REGULATIONS – GENERAL	2
2	SPORTING REGULATIONS: CHAMPIONSHIP EVENTS & RACE PROCEDURES	11
3	SPECIFIC CHAMPIONSHIP REGULATIONS	19
4	CHAMPIONSHIP RACE PENALTIES & JUDICIAL PROCEDURES	24
5	TECHNICAL REGULATIONS	28
6	COMMERCIAL REGULATIONS	46
7	2026 SUPPORT SERIES ENVIRONMENTAL GUIDELINES 2026 CIRCUIT GREEN CHARTER GUIDELINES	56

APPENDICIES

A	GINETTA GT CHAMPIONSHIP DECAL LAYOUT	58
B	GINETTA GT CHAMPIONSHIP RACE SUIT LOGO PLACEMENT	59
C	MOTORSPORT UK RACE WITH RESPECT	60

1. SPORTING REGULATIONS – GENERAL

[SRO Motorsport](#) are determined to create a Championship which is cleanly fought and with good sporting behaviour.

1.1 TITLE & JURISDICTION

The 2026 Protyre Motorsport Ginetta GT Championship is organised and administered by the British Racing and Sports Car Club (BRSCC) in accordance with the National Competition Rules (**NCR**) of Motorsport UK (incorporating the provisions of the International Sporting Code of the FIA) and these Regulations.

Motorsport UK Championship Permit No: **CH2026/R057**

Race Status: **Interclub**

Motorsport UK Championship Grade: **C**

The Organiser reserves the right to amend or vary the Sporting Regulations in accordance with **NCR Ch.3 App.10 Art.4.2** at any time before or during the season and further issue additional statements concerning the Regulations from time to time, subject to Motorsport UK approval, and all such statements will be issued by a Bulletin to Motorsport UK and to all registered competitors by email or by post to the address detailed on the Registration Form, or by delivery to the competitor by hand. It is a condition of entry that all competitors, teams, team members and persons associated with any of the above agree to be bound by the Regulations including any amendments, variations or statements relating thereto.

The Championship Permit is granted by the ASN to and held by BRSCC. The Championship Events are organised by BRSCC and the Championship is promoted and administered by [SRO Motorsport](#). The Championship is organised pursuant to the National Competition Rules (**NCR**) of Motorsport UK (incorporating the provisions of the International Sporting Code of the FIA) and these Championship Regulations.

For the purposes of these Championship Regulations BRSCC and [SRO Motorsport](#) shall be jointly and severally referred to as the Organisers, however for the avoidance of doubt BRSCC shall be accountable to the ASN as the Championship Permit Holder.

1.2 OFFICIALS

1.2.1 Championship Co-ordinator

Kelly [Robertson](#), 07917 261 345

1.2.2 [Championship](#) Clerk of the Course

Paul Levitt, 07815 908 928

1.2.3 [Championship](#) Eligibility Scrutineer

[Keith Auld](#), 07778 268 528

Deputy [Championship](#) Eligibility Scrutineer

Clive Greves, 07836 523 172

1.2.4 Championship Stewards

Greg Masters, Trevor Parry, David Simons, Nick Breed

Any three Championship Stewards will constitute a quorum. In the event of any of the Championship Stewards listed above being unavailable or being unable to consider any particular matter due to a perceived conflict of interest, the organisers reserve the right to appoint an alternative Championship Steward or, if deemed to be necessary, more than one alternative Championship Steward.

NCR Ch.4 App.1 Art.1.2 The Championship Stewards can only adjudicate upon any disputes irregularities or appeals arising from the published Championship Regulations. They are also empowered to consider any request from the Championship Co-ordinator to penalise any Competitor for any breach of Championship Regulations and after holding a formal hearing those Stewards may impose a penalty in accordance with **NCR Chapter 2** subject to the rights of Appeal to the National Court there provided.

1.3 COMPETITOR ELIGIBILITY

1.3.1 Entrants (Teams) must:

- (a) Be fully paid up valid membership card holding members of the BRSCC.
- (b) Be registered for the Championship.
- (c) Be in possession of a valid Motorsport UK Entrants Licence.
- (d) Must be a [SRO Motorsport](#) Franchised Team as per the [Team Commercial](#) Agreement in **6.2** or granted start permission by [SRO Motorsport](#)

1.3.2 Drivers and Entrant/Drivers must:

- (a) Be current Members of the BRSCC.
- (b) Be Registered for the Championship.
- (c) Be in possession of a valid Motorsport UK Competition Interclub status licence, as a minimum. Or be in possession of the highest grade of National Race Licence or valid FIA International Licence, [including confirmation of a valid medical certification](#), together with their ASN's written consent (**NCR Ch.6 App.3 Art.1.6** and FIA ISC Article **2.3.7.b applies**).
- (d) If participation in the Championship requires absence from education a driver, in full time school education is required to have the approval of their head teacher and a letter stating such approval from the school in order to fulfil registration for the Championship. A driver shall not take time out of their education to participate in motor sport without the prior written approval of their education establishment.
- (e) Where there is no officially licensed entrant the Parent / Legal Guardian or other delegated representative of any driver under the age of 18 will assume the role of an Entrant [**NCR Ch.6 App.3 Art.1.13**] for all purposes under these Championship Regulations and must be present with the driver at all times.
- (f) Only those cars complying with the 2026 Technical Regulations for the Championship and / or any amendments to the Technical Regulations issued from time to time by way of an official Championship Bulletin in accordance with **NCR Ch.3 App.10 Art.4.1.d** will be allowed to compete in any round of the Championship.

(g) Entrants/Drivers must ensure that their cars comply with the conditions of eligibility and safety throughout qualifying and racing.

(h) At any time during an Event, the Championship Clerk of the Course can require a Driver to have a medical examination by the Medical Adviser or their nominee.

(i) The 2026 Protyre Motorsport Ginetta GT Championship will have two categories within the Championship: Pro and Am class. Competitors and Guest Drivers will be able to place themselves in the appropriate category to reflect their driving ability. Competitors must indicate on their Registration Form which category they would place themselves – along with their full racing CV (year, championship, podiums, championship position per year) The Protyre Motorsport Ginetta GT Championship Organisation will review the applications and decide whether to accept it.

(j) The Championship Organiser reserves the right to amend a chosen drivers' category at any time.

(k) Drivers who wish to move class must put in an Official request form (on request from SRO Motorsport) which will be reviewed by the Championship Coordinator. Drivers cannot move class after Round 4 of the Championship.

1.3.3 A Team is a commercial race company or racing team hosting drivers in providing race services or covered accommodation in the Championship and as a result receives financial gain where, in respect of Junior Drivers, the principal is not also the parent/guardian. Being considered as being a Team includes the use of team names, team sticker kits and team race suits/clothing.

A Team shall at all times uphold and respect the provisions of the National Competition Rules and these Championship Regulations as may be amended from time to time and shall;

(a) hold a valid Motorsport UK Entrant licence;

(b) have at least £5 million Public Liability Insurance;

(c) uphold the values of the Respect Code and all applicable Motorsport UK policies and guidance;

(d) act in a professional manner at all times and not act or permit any member of the Team to act in such a manner as to bring motor sport, the Championship or Motorsport UK or any its officers and officials into disrespect;

(e) adhere to the Motorsport UK Safeguarding Policies and guidance documents, complete Safeguarding training when required and ensure that any person undertaking Regulated Activity is the holder of a valid suitability check certificate supplied through Motorsport UK;

(f) ensure that representative(s) and driver coaches attend training/briefing when required;

(g) adhere to the **NCR** in respect of anti-alcohol and illicit drugs as well as **NCR** processes for anti-alcohol and illicit drugs testing;

(h) nominate one member of their Team as the Team Representative at each Event including but not exclusively for the purpose of all judicial proceedings at Events and who shall be present at all judicial proceedings concerning drivers entered under that Team licence in substitution for the driver Parent/Legal Guardian.

1.3.3.1 It is recommended the Team has:

- (a) a designated team member as a 1st 4Sport, Level 2 qualified coach;
- (b) a designated UKAD Certified Advisor, and
- (c) be responsible for carrying out and documenting a risk assessment of their activities; (risk assessment management tool available [from Motorsport UK](#))

1.3.4 All [competitors must sign-on at Events that they compete in and](#) necessary documentation must be presented for checking at all [times upon the demand of the Officials](#).

[1.3.5 Competitors not registered for the Championship may be permitted on an individual round basis and will:](#)

- [\(a\) Be deemed "Guest Competitors"](#)
- [\(b\) Not score points and for the purpose of points scoring will be ignored](#)
- [\(c\) Qualify for Event awards](#)
- [\(d\) Comply with the eligibility as prescribed in Article 1.3 above, with the exception of 1.3.1\(b\) and 1.3.2. \(b\), as appropriate](#)
- [\(e\) Priority of entry will be given to fully registered drivers](#)
- [\(f\) Be subject to any conditions that the organiser may stipulate](#)

1.4 REGISTRATION

1.4.1 All Entrants and or Teams and all Drivers must register for the championship by returning the Registration Form [and submitting it together](#) with the Registration Fee to the [Championship](#) Co-ordinator prior to the Final Closing date for the first round being entered. Entries are on a 'first come first serve basis' but always subject to **1.3.1** and **1.3.2**.

1.4.2 The Drivers Registration Form must be completed in full, signed by the driver, and if applicable countersigned by the Entrant / Team and be accompanied by the Drivers Registration Fee in full, in order to be considered. If applicable the Drivers Registration Form must also be counter signed by the Parent or Legal Guardian of the driver in all cases where the driver is under the age of 18 years at the date of Registration. The Entrant's / Team Registration Form must be completed in full and be signed by an authorised person being a director in the case of a Limited Liability Company or a partner or sole principal where applicable.

1.4.3 A maximum of **38** Registrations will be accepted for entry into the Championship. Entrants/Teams will be limited to entering 6 drivers at any one event.

1.4.4 The acceptance or rejection of a Registration application will be based upon the information given on the Registration Form. It is therefore a condition of Registration that drivers Entrants and Teams accept that the Organisers reserve the right to reject Championship Registration Applications and /or entries to individual events by any applicant for Championship Registration without giving reasons [**NCR Ch.6 App.1 Art.11 applies**].

- 1.4.5 The Registration Fee is **£16,500+VAT**- Made payable to:- **SRO Motorsport, 110 Old Brompton Road, London, SW7 3RA**. This Registration fee is fully inclusive of entry fees to all rounds of the Championship. Entry fees may not be paid by accounts. The Registration fee is NOT inclusive of BRSCC membership

A Registration once made and accepted shall constitute a legally binding contract and a Registration may only be withdrawn without penalty with the mutual consent of both parties. An Entrant or driver whose Registration is accepted and who otherwise fails to participate in the Championship shall forfeit their Registration fees in their entirety.

- 1.4.6 Registration numbers will be the permanent Competition numbers for the Championship. Numbers 1-3 are reserved for the Championship Organisers use and will be allocated to returning drivers.
- 1.4.7 Registrations will be accepted from 01 December 2025 until the closing date for entries to the last round. The Organisers reserve the right to decline any driver's registration application for the Championship, without explanation.
- 1.4.8 Acceptance via means of invitation or rejection of registration, including withdrawing or revoking a Registration, is entirely at the discretion of the organisers.
- 1.4.9 At the sole discretion of the organisers, guest drivers may compete in the Championship. Championship Regulation **1.3.5** refers.
- 1.4.10 The presentation of the car is fundamental to the profile of the Championship, its sponsors and its audience. Therefore, in considering whether to permit any car to race, at any point during the season, the organisers will regard as paramount the presentation of the car. In taking into account its appearance inherent in which is the standard of its presentation (including interior) they may disqualify any car which they consider may prejudice the reputation of the Championship or is otherwise unacceptable. Disqualification from an event will be at the discretion of the Clerk of the Course. In the case of persistent offences, the matter will be referred to the Championship Stewards which could lead to disqualification from **further participation in** the Championship.

This may include where the car is presented at a race event bearing accident damage sustained at a previous event and which has not been subject to the completion of a full and proper repair. Note: A double/triple header will be regarded as one event for the purposes of this regulation.

- 1.4.11 Vehicles, decals, overalls & or patches: Competitors overalls must be clean and maintained to a reasonable standard. Patches must be affixed in instructed locations and cars deemed to be of an unacceptable standard of presentation may not be permitted to race (**Appendix A & B**).
- 1.4.12 Promotional activities: Competitors may be asked and will be expected to participate in Championship promotion activities at the circuits, as requested by the organisers/co-ordinator.
- 1.4.13 Deleted
- 1.4.14 Deleted

1.5 CHAMPIONSHIP EVENTS

The Championship will be contested over 6 Events as follows:

ROUNDS	VENUE	DATE	EVENT
<u>1,2</u>	<u>Silverstone*</u>	<u>25/26 April</u>	<u>SRO</u>
<u>3,4,5</u>	<u>Oulton Park*</u>	<u>23/25 May</u>	<u>SRO</u>
<u>6,7,8,9</u>	<u>Croft*</u>	<u>27/28 June</u>	<u>G FEST</u>
<u>10,11,12</u>	<u>Snetterton*</u>	<u>15/16 August</u>	<u>SRO</u>
<u>13,14,15</u>	<u>Donington Park*</u>	<u>05/06 September</u>	<u>SRO</u>
<u>16,17,18</u>	<u>Brands Hatch*</u>	<u>26/27 September</u>	<u>SRO</u>

* Subject to a valid track licence

- 1.5.1 In accordance with **NCR Ch.12 App.2 Art.4** the Organisers reserve the right to amend the published list of dates and rounds in which case all registered competitors will be informed of the amendments by Official Bulletins, emailed to all registered competitors to the email address provided on the registration form.
- 1.5.2 The Championship will feature **6** Official pre-event test days. The dates will be confirmed via an Official [SRO Motorsport](#) Bulletin in due course.

1.6 SCORING

The Protyre Motorsport Ginetta GT Championship points will be awards where a driver finishes in the overall race.

- 1.6.1 Points will be awarded to Protyre Motorsport Ginetta GT Championship competitors listed as classified finishers in the Final Results [as follows](#):

35, 30, 26, 22, 20, 18, 16, 14, 12, 11, 10, 9, 8, 7, 6, 5, 4, 3, 2, 1 plus **1** for the fastest lap in qualifying and **1** for fastest lap in each race.

- 1.6.2 Competitors must count their results from all Championships Rounds less TWO rounds which will be dropped irrespective of whether the competitor be classified as a finisher.

A competitor may not drop a round if any of the following incidences occur with respect to that said round:

- (a) The Competitor is subject to a Written Reprimand, Fine, Time, Grid Place or Position/Lap Penalty for any offence listed in **NCR. Ch.2 App.12 Art.1.2**.
- (b) The competitor is disqualified from a classified race result for any Sporting or Technical Infringement.

- 1.6.3 Ties will be resolved in accordance with **NCR Ch.4 App.3 Art.4**.

- 1.6.4 Where the race distance has been reduced (**2.6**) the following points will be applied:

- (a) No points will be awarded to the drivers or teams if the leader has completed less than two laps.

- (b) The following points will be awarded to the drivers and teams if the leader has completed two or more than two laps but less than 75% of the original race time:

20, 18, 16, 14, 12, 11, 10, 9, 8, 7, 6, 5, 4, 3, 2, 1 plus **1** for the fastest lap in qualifying and **1** for the fastest last in each race.

Full points (**1.6.1**) will be awarded if the leader has completed more than 75% of the original race time.

The above will be based on the final classification and results published on this basis.

1.6.5 [Refer to Art. 1.3.5 regarding guest competitors.](#)

[1.6.6 Competitors can only score points if they enter the full Championship season or enter \(must take part in all qualifying session for all entered events\) a minimum of 3 Championship events.](#)

1.6.7 The Team Classification is a classification independent from the driver classification and applies only to Registered Teams / Entrants conforming with Article **1.3.1** and **1.6.8** of these Championship Regulations. At the start of the season each Team must submit to the Championship Coordinator their nominated vehicle(s) to score points for the Team classification. Any car entered in accordance with Article **1.3.5** is not eligible to score these points.

1.6.8 Any changes to these nominations during the Championship must be made in writing to the Championship Coordinator by the Entrant / Team. This must be received 48 hours prior to first official sessions of the weekend where the change is to occur. The Championship Coordinator reserves the right in [their](#) entire discretion to accept or decline or cancel the nomination of a nominated vehicle(s).

1.6.9 Points will be allocated to the top two scoring vehicles from each Team at each round using the points system described in section **1.6.1** and **1.6.4** where the race distance is reduced. To qualify for the Team award, Teams must be licensed as per **NCR Ch.4 App.0 Art.1.16**. Any car entered in accordance with Article **1.3.5** is not eligible to score these points.

1.6.10 Only Teams with Registered Competitors that are classified as finishers at the first [Event](#) of the Championship will be eligible to compete in the Teams Championship.

1.6.11 All year end results are provisional until announced as official by the organisers.

1.7 AWARDS

1.7.1 All awards are to be provided by the [SRO Motorsport](#).

1.7.2 PER ROUND

Trophies to 1st, 2nd, 3rd in each class.

1.7.2.1 Trophies will be presented to the three highest finishers in class. – ‘Pro’ and ‘Am’.

1.7.3 CHAMPIONSHIP AWARDS

Trophies

[\(a\) Pro Championship - Trophies will be awarded to the 1st, 2nd and 3rd highest placed competitors in class.](#)

(b) Am Championship - Trophies will be awarded to the 1st, 2nd and 3rd highest placed competitors in class.

(c) Teams Award – A trophy will be awarded to the winning Team Registered for the Team’s championship and conforming with these Championship Regulations.

(d) For the avoidance of doubt, any car entered in accordance with Article **1.3.5** is not eligible to score these points.

Championship Prizes

Protyre Motorsport Ginetta GT Championship: Pro Class

Champion: £20,000 discount towards a 2027 British GT4 entry fee, £20,000 Ginetta parts credit and GT4 test with Ginetta.

2nd Place: Half price entry fee towards 2027 British GT4 and £10,000 Ginetta parts credit.

3rd Place: £5,000 discount towards a 2027 British GT4 entry fee and £5,000 Ginetta parts credit.

Protyre Motorsport Ginetta GT Championship: Am Class

Champion: £20,000 discount towards a 2027 British GT4 entry fee, £20,000 Ginetta parts credit and GT4 test with Ginetta.

2nd Place: Half price entry fee towards 2027 British GT4 and £10,000 Ginetta parts credit.

3rd Place: £1,000 discount towards a 2027 British GT4 entry fee and £3,000 Ginetta parts credit.

1.7.3.1 Ginetta Credit must be redeemed within a 12-month period of being issued to the driver. Ginetta Credit must be used by the driver it has been issued to and is non-transferable. All Entry prizes are for the driver in receipt of the prize and are non-transferable.

1.7.3.2 All prizes detailed above will only be issued to Competitors whose accounts (if applicable) with Ginetta Cars and SRO Motorsport are up to date as at close of business on 05 October following the race season. Any Competitor whose accounts are not up to date as of close of business on 05 October following the race season relinquishes all rights to prizes.

1.7.3.3 In the event of the average grid size being less than 10 cars over the course of the Championship all prizes will be reduced in value by 50%.

1.7.4 PRESENTATIONS

Awards will be presented at the end of each round, or at the subsequent **event**. Championship awards will be presented at the annual awards dinner hosted by **SRO Motorsport**, all Championship Prizes will not be eligible to collect if the Driver is not present. An additional Championship Trophy will be presented by the BRSCC at its Annual Championship Prize Dinner (date and venue to be announced by BRSCC). Any such recipient failing to attend these events will not be eligible to receive any prizes which may otherwise have been presented. Such prizes will be with-held and may not be re-presented to any other person unless prior consent has been given from **SRO Motorsport** Cars in writing.

1.7.5 ENTERTAINMENT TAX LIABILITY

In accordance with current UK government legislation, the Organiser is legally obliged to withhold income tax at the basic rate (currently 20%) on all payments to non-UK resident sportspersons and entertainers, and to account for this to HMRC using form FEU1, the quarterly return of payments made to non-resident entertainers and sportspersons.

A non-UK resident is defined as someone who does not have a normal permanent residence in the UK. The UK does not include the Isle of Man, Channel Islands or the Republic of Ireland. This means that, as the organiser, SRO Motorsport /BRSCC is required to deduct tax at the current rate applicable from any such payments they may make to non-UK residents.

Under certain circumstances, competitors may apply to HMRC for a reduced withholding tax rate, or for an exemption, if they can demonstrate that the standard deduction exceeds their actual UK tax liability. Such applications must be submitted in writing at least 30 days before the payment is due.

For further information contact:- Charities, Savings and International 1, HM Revenue and Customs, BX9 1AU. Tel: 0300 322 7877

1.7.6 TITLE TO ALL TROPHIES

If Provisional Results or Championship Tables are revised after any presentations and these revisions affect the distribution of any awards and/or prizes the competitors concerned must return such awards to the organisers in good condition and in full within 7 days of them being requested to allow them to be reallocated.

1.7.7 BONUSES

The organisers/sponsors/promoters reserve the right to provide additional awards for and during the championship.

2 SPORTING REGULATIONS: CHAMPIONSHIP EVENTS & RACE PROCEDURES

2.1 ENTRIES

2.1.1 Competitors are responsible for sending in correct and complete entries with the correct entry fee prior to the closing date for entries before each event.

The Championship Registration Forms can be found online: <https://hub.ginetta.com/>

2.1.2 Incorrect or incomplete entries (including driver to be nominated entries) are to be held in abeyance until they are complete and correct. The date of receipt for acceptance of entry purposes shall be the date on which the **Event** Organiser receives the missing or corrected information or fee.

2.1.3 Any withdrawal of Entry or Driver/Car changes made after the acceptance of any entry must be notified to the **Event** Organisers in writing. **NCR Ch.3 App.11 Art.1.1.l** applies.

2.1.4 Reserves will be listed in the Final List of Entries published with Final Instructions or in a Bulletin. All Reserves will practice (subject to **NCR Ch.12 App.6 Art.3.6**) and replace withdrawn or retired entries in Reserve Number order. If Reserves are given Grid Places prior to issue of the first Grid Sheets for any round the times set in Practice shall determine their grid positions. If Reserves are given places after publication of the grid sheet and prior to cars being collected in the Official "Assembly Areas" they will be placed at the rear of the Grid and be started without any time delay. Otherwise, should a grid place become available they will be held in the Pit Lane and be released to start the race after the last car to start the green flag lap or the last car to take the start has passed the start line or pit lane exit, whichever is the later. Such approval to start **MUST** be obtained from the Clerk of the Course.

2.2 BRIEFINGS

2.2.1 Organisers **must** notify competitors of the times and locations for all briefings in the Final Instructions for all **Events**. Briefings are mandatory so competitors must attend all briefings; if a driver arrives after the start time or misses a briefing, they may be liable to a fine, in accordance with the **NCR. Any Written briefing is an Official Document.**

2.3 QUALIFICATION PRACTICE

2.3.1 The minimum period of qualifying to be scheduled at all events will be **ten** minutes. Should any Qualifying session be disrupted the Clerk of the Course shall not be obliged to resume or re-run the session; the decision of the Clerk of the Course shall be final.

2.3.2 Any driver who has not raced over the course in its current layout within the preceding **24 months** must complete three practice laps in the car to be raced in order to satisfy the Clerk of the Course as to their competence. The Clerk of the Course and / or Stewards of the **Event** shall have the right to disqualify any driver whose qualifying times and / or driving are considered to be unsatisfactory, as per **NCR Ch.12 App.6 Art.3.5**. In the case of force majeure, provided that a Driver has satisfactorily completed 3 (three) laps at an official Championship test day in that season and in a similar car at that circuit prior to the Event, it will not be necessary to complete 3 (three) laps of qualifying to qualify for the race.

2.3.3 Each driver's fastest qualifying time will determine the grid for the first Championship race at each Event. Each driver's second fastest qualifying time will determine the grid for the second Championship race at this Event. **The starting grid for the third race (where one is scheduled) will be formed from the finishing order of the second race, as published by the official timekeepers. Competitors not classified as finishers in the second race will be placed on the starting grid for the third race after the last classified competitor according to the number of laps covered.**

- 2.3.4 Exceptionally, for the Croft G FEST (27/28 June), there will be ONE qualifying session and TWO races on each day, Saturday and Sunday. Each driver's fastest qualifying time will determine the grid for the first Championship race at each Event. Each driver's second fastest qualifying time will determine the grid for the second Championship race at this Event.
- 2.3.5 Under the provisions of **NCR Ch.12 App.10 Art.3.1** the Clerk of the Course may disallow any lap time achieved during the qualifying session where the driver has been reported for breaching track limits.
- 2.3.6 During the course of any qualifying session all competing cars must remain in the Pit Lane while not on the track. At no time will any competing car be allowed in the Pit Garages or Paddock areas until such time as the qualifying session has ended and the car cleared from any post-qualifying scrutineering checks and released from Parc Fermé except with the express permission of the Championship Clerk of the Course.
- 2.3.7 After taking the Chequered Flag competitors are required to progressively and safely slow down remain behind any competitor's ahead of them and proceed directly to the designated Parc Fermé area without stopping unless directed by an Official of the **Event**. Cars must remain in the designated Parc Fermé area until formally released by the **Championship** Eligibility Scrutineer.
- 2.3.8 Any stationary cars in the Pit Lane at the end of a qualifying session come under Parc Fermé conditions at the showing of the Chequered Flag and should be taken directly to the designated Parc Fermé area.
- 2.3.9 Where through force majeure it is not possible to hold a qualifying session the grid for that race will be formed according to the current Championship driver standings. Where there is a tie on points the competitor with the best result in the previous round will take priority.
- 2.3.10 In the event of a qualifying session being shortened resulting in a competitor failing to set a time, that competitor will be placed at the rear of the grid. Should more than one competitor be affected, the order of which those competitors are placed at the rear of the grid will be determined by Championship driver standings.
- 2.3.11 In the event of Qualifying not being ran at the first round of the Championship the grid will be formed based on Official Pre-Event Practice 2.
- 2.3.12 If mechanical means are used by the marshals to remove the car to a safe position, the car concerned cannot re-join the session. Where deemed necessary, the Clerk of the Course may at their sole discretion allow a car to re-join the session but any future laps it completes in that session will not be timed or will be disallowed.

2.4 RACES

- 2.4.1 The standard minimum scheduled race distance shall be 20 minutes whenever practicable and will be set by the race Organisers. Should a race distance reduced at the discretion of the Clerk of the Course or Stewards of the **Event** prior to the start of the race, it shall still count as full points scoring round.
- 2.4.2 When in wet conditions the rearward facing red warning lights must be illuminated.
- 2.4.3 If weather conditions significantly change after leaving the Assembly Area and before the race start the start will be delayed and Entrants/Drivers will be allowed to change onto the eligible wet tyre. The maximum delay will be 10 minutes before the 2 minutes countdown board is shown.
- 2.4.4 Should any race be disrupted (**2.6**) the Clerk of the Course shall not be obliged to resume or rerun the race (**NCR Ch.12 App.6 Art.9.3**) (**1.6.4** above applies)
- 2.4.5 If mechanical means are used by the marshals to remove the car to a safe position, the car concerned cannot re-join the session.
- 2.4.6 At the end of each session, all drivers must cross the Finish Line only once.

2.5 RACE STARTS

- 2.5.1 All cars will be released to form up on the grid prior to the start in formation as specified on the grid sheet.
- 2.5.2 When the signal is given, the cars will be released on to the circuit behind the Safety Car and led to the grid. Once the train of cars following the Safety Car has left the Assembly Area, the Assembly Area and Pit Lane Exit will be closed.
- 2.5.3 The start will be via a rolling start.

The countdown procedures/audible warning sequence shall be:

- (a) 1 minute to start of Green Flag/Pace lap - Start Engines/Clear Grid.
 - (b) 30 Seconds - Visible and audible warnings for the start of Green Flag/Pace lap.
 - (c) Green Flag – Start of the green flag lap.
- 2.5.4 Upon the green flag, cars will begin the formation lap behind the safety car maintaining their starting order. During this lap practice starts are forbidden and the formation must be kept as tight as possible, excessive weaving to warm up tyres (using more than 50% of the track width) and falling back in order to accelerate is prohibited.
- 2.5.5 Any car driven into the pits on the Green Flag lap shall be held in the pit lane and may start the race after the last car to take the start from the grid has passed the start line or pit lane exit, whichever is the later.
- 2.5.6 Any car unable to join the train of cars following the Safety Car from the Assembly Area shall be held in the Pit Lane and may only exit the Pit Lane after the last car has passed the Pit Lane Exit on the Green Flag Lap but shall only do so under the instruction of the Pit Lane Marshals. The car must then join the train at the back of the grid in front of any car with a time delay.
- 2.5.7 If a car is unable to join on the Green Flag Lap it shall be held in the Pit Lane and may only start the race after the last car to take the start has passed the Pit Lane Exit on the first racing lap but shall only do so under the instruction of the Pit Lane Marshal.
- 2.5.8 Any Driver(s) unable to maintain their grid position on the Green Flag Lap to the extent that all other cars are ahead of them may complete the Green Flag Lap but must remain at the rear of the last row of the grid, but ahead of any cars to be started with a time delay. Any Driver(s) unable to maintain their grid position on the Green Flag Lap, but who still has other moving competing cars behind them may regain their allocation grid position(s). However, this must be undertaken by exercising maximum caution.
- 2.5.9 Overtaking during the formation lap is forbidden unless a car is delayed leaving its grid position and cars cannot avoid overtaking it without delaying the remainder of the field. In this case, Drivers may overtake only to re-establish the original starting order. Any Driver delayed in this way and who is unable to re-establish the original starting order before crossing the Intermediate Timing Point 2 or another location advised by the Clerk of the Course briefing notes for the Event must drop to the back of the entire grid and start the race from there.
- 2.5.10 Any Driver who is delayed leaving the grid and is stationary after the remainder of the cars have crossed the Line must not overtake another moving car and must start the race from the back of the grid. If more than one Driver is affected, they must start the race from the back of the grid in the order in which they left to complete the formation lap. If the Line is not situated in front of pole position, for the purpose of this Article only, it will be deemed to be the white line one metre in front of pole position.
- 2.5.11 A penalty will be imposed on any Driver who, in the opinion of the Clerk of the Course, unnecessarily overtook another car during the formation lap.

- 2.5.12 The speed of the Safety Car will be determined by the Clerk of the Course for the formation lap.
- 2.5.13 If conditions so require, the Clerk of the Course may ask the Safety Car to cover one or more additional formation laps. In that case, the start of the race, for the sole purpose of race distance, is considered as having been given at the end of the first formation lap.
- 2.5.14 Drivers in their cars must keep the formation as tight as possible maintaining the distance from the cars in front until the start signal has been given. Once all cars are lined up side-side for the start, the Safety Car will pull off the track into the pit lane at the end of the [last] formation lap. The car in Pole Position must maintain its speed until the start signal is given. Unless otherwise specified in the briefing, the start signal will be given by turning off the red lights.
- 2.5.15 During the formation lap the red light will be on. No car may overtake another one before the starting signal is given.
- 2.5.16 There will be a rolling start in accordance with **NCR Ch.12 App.6 Art.6.3**. Race timing will commence at the point that the red lights go out.
- 2.5.17 The Organisers reserve the right to change the start procedure at any time, by confirmation of an Official bulletin.
- 2.5.18 Any driver adjudged to have committed a False Start or breached any part of the Start Procedure will **be subject to a 10 seconds time penalty being added to their race time.**
- 2.5.19 In the exceptional circumstance, the race may be started behind the Safety Car. In this case, when the green lights are illuminated or a green flag is displayed at the start line, the Safety Car will leave the grid with its orange light illuminated and all competition cars following in grid order no more than 5 car length apart. All other marshal's posts and/or circuit light panels will display a Safety Car Board and Yellow Flag, which will be the signal to the Drivers that the race will be started behind the Safety Car. There will be no formation lap and the race will start when the green lights are illuminated, or a green flag is displayed at the start line. **NCR Ch.12 App.8 Art.2** shall apply with regards to the end of the safety car period.
- 2.5.20 The organisers reserve the right to merge/combine grids with other formulae. In those cases, the grid will be formed in two parts. The organisers will clarify in Official Documents for the event(s) which formulae will form the first and second part of the grid respectively. Where possible, there will be a two-row gap between the two parts of the grid. Both parts of the grid will start under the same starting signal (there will not be a time delay).**

2.6 SESSION RED FLAG

- 2.6.1 Should the need arise to stop any race or practice, RED LIGHTS will be switched on at the Start Line and RED SIGNALS will be displayed at the start line and at all Marshals Signalling Points around the circuit.

This is the signal for all drivers to cease circulating at racing speeds, to slow to a safe and reasonable pace and to return to the starting grid area, during a race, which will automatically become a parc ferme area, unless otherwise directed by officials. **Marshals should revert to displaying yellow flags to indicate to Drivers the particular location of any incident hence supplementing the Light Panels.**

Cars should not enter the pits unless directed to do so and all cars in the pit lane during a red flag period must take any restart from the pit exit. Work on cars already in the Pits must cease when a race is stopped.

- 2.6.2 **Case A – Less than two race laps completed by the race leader.**

The race will be declared a “No Contest” and available competitors will restart from their original grid positions. Competitors unable to take the restart may be replaced by reserves who will start from the back of the grid in reserve order. Gaps on the grid should not be closed up. The Clerk of the Course may order that the duration of the re-run of any race shall be a shorter distance than originally scheduled or may be abandoned altogether. The duration of the re-run will be determined as the duration of the race.

2.6.3 **Case B – More than two race laps completed by the race leader but less than 75% of the scheduled duration.**

Any race stopped after the leader has completed more than two laps but less than 75% of its duration will be considered as the first part of the race. Competitors will be restarted from a grid set out in the finishing order of this first part, which shall be based upon the order of crossing the finish line at one lap less than the number of laps completed by the leader at the time of first showing the Red Signal. Only vehicles which are proceeding under their own power, in accordance with **NCR Ch.12 App.8 Art.1.7.j** at the showing of the Red Signal will be classified in this first part (**NCR Ch.12 App.6 Arts.9.1.c** and **NCR Ch.12 App.6 Arts.9.2-9.3** also apply). The result of the race will be the finishing order at the end of the restarted race (see **NCR Ch.12 App.6 Arts.9.1.d**).

2.6.4 **Case C - More than 75% of race completed**

If the leader has completed more than 75% of the race distance or duration it shall not be restarted and the results will be declared in accordance with **NCR Ch.12 App.6 Arts.9.1.e**, unless the Clerk of the Course, in consultation with the Stewards deems it appropriate to restart the race.

2.6.5 In the event of a restarted race, **NCR Ch.12 App.6 Arts.9.2** will apply to any repairs to cars required during the interval.

2.6.6 Entrants / Drivers are advised that two Red Flag race stoppages in any one round may result in their race being placed at the end of the day's racing, time permitting. Similarly, Entrants / Drivers are advised that, should the timetable be running late, their race may be postponed until later in the timetable to allow for a British GT race to start at its scheduled start time and/or their scheduled race distance may be reduced by the Clerk of the Course in consultation with the Championship Coordinator and with the approval of the Stewards of the **Event**.

2.6.7 If a race cannot be run or re-started at a venue for any reason then at the Organisers' entire discretion reasonable attempts will be made to provide a substitute race at another event but the Organisers are not contractually bound to provide such substituted race(s) and no refund of any Registration Fee shall be payable and with such occurrence of loss of race(s) being deemed force majeure. Any such substitute race will utilise the original grid and only competitors detailed on the original grid sheet will be eligible to participate.

2.7 **PITS, PADDOCK & PITLANE SAFETY**

2.7.1 **Pits & Paddock**

Competitors must ensure that the Motorsport UK, Circuit Management and Organising Club Safety Regulations are complied with at all times.

2.7.2 **Pit Lane**

The outer lane or lanes are to be kept unobstructed to allow safe passage of cars at all times. The onus shall be on all Drivers to take due care and respect the Pit Lane speed limits. All drivers, teams and pit crew members must familiarise themselves and comply with **NCR Ch.12 App.11 Art.3.6**.

During Qualifying sessions and Races, Drivers leaving the Pit Lane will do so on their own responsibility however a marshal with a Blue Flag will warn of cars approaching.

2.7.3 **Refuelling**

Refuelling is not permitted during any practice, qualifying or race.

Outside of any session and whilst vehicle is not under Parc Ferme, refuelling may only be carried out in accordance with the **NCR**, Circuit Management Regulations and Supplementary Regulations or Final Instructions issued for each **Event**.

2.7.4 Speed Limit

The Pit Lane Speed Limit will be **40kph** unless otherwise specified in event Final Instructions.

The Penalty for breaching the pit lane speed limit will be a Drive through Penalty in the race but if the infringement is notified to the Clerk of the Course after the end of a race, they may levy a fine of £10 for each kph above the speed limit (this penalty will also apply for qualifying) or impose a retrospective time penalty. Signs and / or lines are used to indicate the beginning and end of the area to which the speed limit applies.

2.7.5 Deleted

2.7.6 Tyre Changes

2.7.6.1 Tyre changes may be carried out on the car in the pits/working area of the pit lane. Tyre changes can only be carried out due to a change in condition, or a puncture/damage to tyres.

Only ambient air, pressurised, can be used to fill the tyres or operate the air guns, the use of Nitrogen is forbidden.

2.7.6.2 Once the wheels have been changed the hose must be removed in order to bring the car down. No other systems may be used to bring the car down onto its wheels.

2.7.6.3 Mechanics must not throw the wheels or drop them.

2.7.7 Deleted

2.8 RACE FINISHES

After taking the Chequered Flag drivers are required to:

- (a) Progressively and safely slow down.
- (b) Remain behind any competitors ahead of them.
- (c) Return to the pit lane/entrance as instructed. Only the driver and team member authorised by the Eligibility Scrutineer or Chief Scrutineer are permitted in Parc Ferme.
- (d) Comply with any directions given by marshals or officials.
- (e) Keep their helmets on and harness done up while on the circuit or moving in the pit lane.

2.8.1 Once in the Parc Fermé area, Drivers required for the podium presentations must proceed immediately to the podium. The Drivers required will be those finishing first, second and third.

2.9 RESULTS

All Practice Timesheets, Grids, Race Results are deemed provisional until all vehicles are released by Scrutineers after Post Practice/Race Scrutineering and/or after completion of any Judicial or Technical Procedures. (**NCR Ch.3 App.6 Art.1.4** applies).

2.10 TIMING MODULES

2.10.1 All competitors will be required to fit Electronic Self Identification Modules (transponders) to their cars for the purposes of accurate timing. Transponders may be purchased from Timing Solutions Limited. Holders for these and detailed fitting instructions will be issued with the transponders, and it will be the responsibility of the competitor to fit these in the car in the position and manner specified. The Modules must be in place and functioning correctly for all championship qualifying practice sessions and races.

The setting and servicing of these items must only be carried out by properly authorised Motorsport UK licensed Timekeepers.

Competitors will be charged by the timing company for replacement of the Modules due to misuse or loss at any time during the season. **NCR Ch.12 App.6 Art.2.2** applies.

2.10.2 Competitors may not place electronic timing equipment within five metres of the official Start, Finish or any other official timing lines at any event or test session/day. Any such equipment placed within these zones will be removed.

2.10.3 All competitors will be required to fit a **TSL on-board signalling & GPS tracking system** to their cars for the purposes of using the required 'My Laps RaceLink Club' System. This system links directly with the dash/light bar to broadcast multiple warning flags or relevant colours, i.e., Safety Car, red flag, yellow flag with sector, black/white flag etc. The receivers must be in place and functioning correctly for all Championship qualifying practice sessions and races. Detailed fitting instructions will be issued with the receivers and it will be the responsibility of the competitor to fit these in the car in the position and manner specified. **TSL Timing** will provide the MyLaps RaceLink receiver at each round - there will be an annual hire fee for the MyLaps RaceLink receiver. It will be required that each car has a loom and external antenna (all to be mounted in the same car position). Competitors will be charged by **TSL Timing** for replacement of the receiver due to misuse or loss at any time during the season.

2.11 DIFFICULTY

2.11.1 If any Driver experiences a serious mechanical problem at any stage, they must leave the track as soon as it is safe to do so and park in a position of relative safety. The car must be left in neutral and any removable steering wheel must be reattached before the Driver gets behind the protective safety barriers. The Driver should stay with the car to assist recovery crews with the task of bringing the car back to the pits at the end of the session.

2.12 ASSISTANCE

2.12.1 Regardless of the circumstances, once a Driver has received mechanical assistance to move their car from one position to another they are not permitted to continue within that particular session or race even if, after being moved into a position of safety, they feel that they are able to continue.

2.13 SPARE CARS

2.13.1 Replacement cars may only be permitted with the express permission of the Clerk of the Course and the Championship Coordinator. The presentation of a spare car for scrutineering must be done in accordance with the regulations set out within the **NCR**. A competitor using a replacement car will incur a 20-point reduction in their Championship points total.

2.13.2 A replacement car is considered to be any car other than that which was originally scrutineered for a particular event.

2.14 OPERATION OF SAFETY CAR

The Safety Car will be brought into operation and run in accordance with **NCR Ch.12 App.8 Art.2.**

2.15 PARC FERMÉ

At all events the showing of the Chequered Flag (for both Qualifying and Racing) will indicate the commencement of Parc Fermé Regulations. Any vehicle that is in the pit lane at this time will be under Parc Fermé rules.

Parc Fermé Regulations will apply to the area between the Start / Finish Line and the Parc Fermé entrance. Any area deemed necessary by the Eligibility Scrutineer and / or their nominated representative will be subject to Parc Fermé conditions with no exceptions.

It is prohibited to work on any vehicle after the chequered flag has been shown. This includes tyre pressure checking, wheel changes or changes of driver unless authorised by the Eligibility Scrutineer or their Deputy.

Any vehicle in the pit lane must be immediately taken to the designated Parc Fermé area. No team personnel may enter Parc Fermé unless authorised by the Eligibility Scrutineer or their Deputy.

No tools of any type may be passed by team members or mechanics to drivers whilst in Parc Fermé unless requested by the Eligibility Scrutineer or their Deputy.

Competitors are reminded that the area designated as Parc Fermé area is a secure area and it is not permitted for any supporters to be in Parc Fermé unless authorised by the Eligibility Scrutineer or their Deputy.

Team personnel are only allowed into the Parc Fermé area at the invitation of the Series Eligibility Scrutineer. Should unauthorised Team personnel be present in Parc Fermé, they render their car liable to disqualification from the Event. Any breach to Parc Fermé regulations will be reported to the Clerk who may impose penalties as appropriate. At their discretion the Clerk of the Course or Organisers may assign other penalties to any driver / Team breaching Parc Fermé regulations. On request of the Eligibility Scrutineer, the Parent or Legal Guardian of the driver will be permitted in Parc Fermé.

All personnel entering the Parc Fermé must wear their 'Ginetta Arm Band' – two arm bands will be provided to each car at the start of the season. Only **TWO** members of Team Personnel per car is permitted to enter the Parc Fermé area.

3. SPECIFIC CHAMPIONSHIP REGULATIONS

3.1 MOTORSPORT UK'S RESPECT CODE

By registering for the Championship all competitors and their associates commit to positively promote and demonstrate the Motorsport UK's Respect Code which is appended to these regulations (**Appendix C**).

- 3.1.1 Where any reports of disrespectful conduct are judged to be well founded the Championship organisers may issue warnings or require remedial actions and/or report the matter to the Championship Stewards who may impose appropriate penalties which can include loss of Championship points and/or race bans through to [Disqualification from further participation in the Championship](#) and referral to Motorsport UK.
- 3.1.2 It is imperative that we promote the safety and wellbeing of young people and adults at risk. In addition to this all participants must be aware of their behaviour and conduct at all times and abusive language and harmful behaviour will not be tolerated. Any such incidents must be reported to the Championship Coordinator and/or Safeguarding Officer who will also relay the report Motorsport UK. Details of the Motorsport UK Policies and Guidelines are available at www.motorsportuk.org/resource-centre by selecting Policies and Guidelines.

3.2 RACE CONTROL TO CAR

- 3.2.1 For all official sessions, including any Free Practice, Qualifying and Races, all competitors must use the mandatory 'Race Control to Car' radio receiver for which the transmitter shall be under the sole control of the Clerk of the Course and used to communicate instructions or warnings to the drivers from Race Control. See **NCR Ch.12 App.4 Art.4.12.c**.
- 3.2.2 Should a competitor not have a working receiver fitted during an official session or fail to comply with any message or instruction(s) from the Clerk of the Course, they may receive a penalty. The responsibility remains with the competitor to ensure their receiver is in full working order during all official sessions.
- 3.2.3 The mandatory receiver may only be purchased directly from the BRSCC.

3.3 PIT TO CAR & TEAM RADIOS

- 3.3.1 It is not permitted to use any personal form of pit to car communication systems during any Free Practice, Qualifying and races at any event during the Saturday and Sunday. Systems will be permitted during Friday test days, and [SRO Motorsport](#) exclusive test days, but all equipment must be removed for all permitted sessions.
- 3.3.2 Radio frequencies used by an Entrant/Driver, Team member, and/or any of their suppliers must be licensed for use in the UK by the appropriate regional office of the Radiocommunications Agency. The Championship Coordinator must be notified prior to the start of the season of the Radio Frequency to be used by the Entrant/Driver, Team members, and/or any of their suppliers. A copy of the Licence or Short-Term Hire Agreement for the frequency must also be submitted. The Championship Coordinator reserves the right to request production of the original Licence/Short Term Hire documentation to verify the use of any frequency by an Entrant/Driver, Team member, and/or any of their suppliers at any time during the season.
- 3.3.3 The Entrant/Driver, Team member, and/or any of their suppliers must at all times comply with the terms and conditions specified from time to time by the Radiocommunications Agency for the use of their radio frequency.

- 3.3.4 In the event that a frequency used by an Entrant/Driver, Team member, and/or any of their suppliers interferes with a frequency used by a local emergency service or other third party the Entrant/Driver, Team member, and/or supplier shall forthwith change its radio frequency to a non-conflicting frequency to the satisfaction of the Championship Coordinator and in accordance with the requirements and prior approval of the Radiocommunications Agency. The Entrant/Driver, Team member, and/or any of their suppliers will be suspended from any on track sessions until a change of frequency has been affected and a copy of the approval of the Radiocommunication Agency submitted to the Championship Coordinator.
- 3.3.5 If an Entrant/Driver, Team member, and/or any of their suppliers wish to change their frequency they must first obtain approval from the Radiocommunications Agency and submit a copy of such approval to the Championship Coordinator.
- 3.3.6 It is not permitted to scramble radio speech transmissions or encode them in any way.

3.4 ONBOARD CAMERAS

All cars must be fitted with two in car judicial cameras that comply with **NCR Ch.7 App.9** which applies in its entirety. Onboard cameras must be switched on and working during all Official Qualifying sessions and Race. It is the entrant's responsibility to ensure that the judicial cameras are fitted and operational during all official qualifying and races, and that the footage produced is of an acceptable quality. One Camera must be a Go Pro and the other camera must be with a combined data logging system. The judicial cameras must be positioned in the centre of the vehicle and must be mounted so to capture an image that provides a 'drivers eye' view that include driver input (ie steering), dashboard and full view of the circuit ahead with a field of vision of approximately 100 degrees. The mounting must be of a mechanical means of attachment sufficiently robust to withstand anticipated stresses and vibration and must not present any sharp edges or projections in the vicinity of the driver's body or helmet.

The cameras must be switched on and be recording at all times when the car is on track during any official qualification session and race. The onus is on the competitor to ensure that the batteries of the cameras are charged, and the cameras switched on to record onto the SD cards during the above-mentioned sessions. The SD card/s may be requested by the organisers or race officials for any purpose and the recorded footage copied for use in broadcast or any other area deemed appropriate by the championship organiser.

Mandatory judicial camera for use within the Championship is as follows;

- (a) Any Go Pro variants from the Hero 2 range or newer

One additional camera/data system must be installed in the car along with the mandatory Go Pro above. The following additional camera are:

- (b) Vbox Data Logging System
- (c) AIM Smarty Cam

Failure to comply when footage from either camera is under review by the Clerk of the Course for judicial purposes will result in the implementation of a fine of £250 for each and every offence.

The SD cards will be distributed by a **SRO Motorsport** official prior to qualifying and races. The onus is on the competitor to ensure the cards are fitted and Judicial cameras are switched on and recording for all Official qualifying and races.

- 3.4.1 It is the responsibility of the competitor / entrant to supply **SRO Motorsport** with EIGHT SD/data cards (FOUR micro-SD cards and FOUR SD cards) that are compatible with the judicial cameras fitted in the competitors car prior to the start of the season.
- 3.4.2 Judicial cameras must be switched on but not before three minutes prior to leaving the assembly area. Data cards will be collected by a **SRO Motorsport** Representative or other official after the end of each session in order for the Clerk of the Course to review footage. Data cards are to remain in the car until collected by a **SRO Motorsport** Representative or other official. Any entrant/driver that fails to comply will be reported to the Clerk of the Course and may result in a penalty during the event. The video/images remain the property of **SRO Motorsport** and it is not to be used on Social Media or for any other public use.
- 3.4.3 During qualifying and races, the only camera permitted in the car will be the official judicial cameras. The only exception to this will be a camera fitted by the television production company in accordance with Commercial Regulations **6.5**. This footage is to be used for judicial purposes; it is at the sole discretion of the Clerk of the Course as to whether competitors will have access to this footage after judicial procedures have been completed.

3.5 RE-SCRUTINY / DRIVER AVAILABILITY

- 3.5.1 Any vehicle involved in an accident or having been modified in any way subsequent to pre-event scrutiny, must be re-presented to the Scrutineers for further examination.
- 3.5.2 At any time during an Event the Organisers acting through the Clerk of the Course may order that a vehicle be re-examined, even if this involves stopping a vehicle while qualifying or racing. Failure to comply with Regulations during a qualifying session or failure to comply with the directions of race officials to undertake a check will result in the loss of that Driver's qualifying times to that point in the session.
- 3.5.3 If a Driver is involved in a collision or incident, they must not leave the circuit (except where medically evacuated) without the consent of the Clerk of the Course, failing which, any judicial action against or relating to that Entrant / Driver may be heard in their absence.
- 3.5.4 Entrants / Drivers must remain available at an Event until any protest period relating to their race has elapsed, failing which, any judicial action against or relating to that Entrant / Driver may be heard in their absence.
- 3.5.5 Entrants' / Drivers' cars may not be removed from the Paddock during an Event after initial scrutineering except for the purpose of competing in the rounds comprised in the Event or with the prior written permission of the Eligibility Scrutineer and Clerk of the Course. The Organisers and / or Eligibility Scrutineer may require the Entrant's / Driver's car to be re-scrutineered at any time.

3.6 SCRUTINEERING PROTOCOL

- 3.6.1 In accordance with Regulation **1.2**, the Championship Organisers will appoint a permanent Eligibility Scrutineer who, with their Team, will be responsible for the scrutineering of the vehicles for the qualifying sessions and races of the Championship.
- 3.6.2 For scrutineering, the Entrant / Driver must present the competing vehicle and mandatory Entrant / Driver safety equipment. The vehicle must be submitted as used in the Championship and must correspond to all applicable Technical Regulations. Alternatively, a Motorsport UK self-declaration form may be required to be submitted electronically.

- 3.6.3 A completed set of online seal forms for each vehicle must be correctly submitted, unless the Eligibility Scrutineer requests otherwise. Details of submissions will be emailed out in pre-event bulletins.
- 3.6.4 Aside from the Eligibility Scrutineer, the vehicles may also be subject to eligibility scrutineering during and after the Event. Vehicles will be selected at the sole discretion of the Eligibility Scrutineer and/or their nominated representative. The Eligibility Scrutineer and / or their nominated representative will make random checks in addition to scheduled scrutineering checks for vehicle eligibility throughout Events. Any infringement will be subject to a report to the Clerk of the Course.
- 3.6.5 Entrants/Drivers must comply with the directives of the Eligibility Scrutineer and/or their nominated representative in respect of scrutineering and of re-scrutineering after the Event.
- 3.6.6 After each qualifying session and race the vehicles must be presented directly for scrutineering. Any area deemed necessary by the Eligibility Scrutineer and / or their nominated representative will be subject to Parc Fermé conditions with no exceptions. This will include the track from the Finish Line to the scrutineering area, the waiting area in front as well as the track from the scrutineering area to Parc Fermé, Teams awnings or working areas, but all areas may be used if necessary.
- 3.6.7 Public and Team personnel must not enter Parc Fermé unless invited by the Eligibility Scrutineer and/or their nominated representative. Should unauthorised Team personnel be present in these areas, this may render their car liable to disqualification from the qualifying session or race. Any breach to Parc Fermé regs will be reported to the Clerk who may impose penalties as appropriate. At their discretion the Clerk of the Course or Organisers may assign other penalties to any driver / Team breaching Parc Fermé regulations. On request of the Eligibility Scrutineer, the Parent or Legal Guardian of the driver will be permitted in Parc Fermé. Entrants must have a nominated person available after each session to assist with the post-race Scrutineering process and be waiting to be invited into Parc Fermé as instructed by the Scrutineer.
- 3.6.8 Cars may be held in Parc Fermé for a minimum of 20 (twenty) minutes after each qualifying session and race until released by the Eligibility Scrutineer.
- 3.6.9 At any time, the Championship Organisers reserve the right to scrutineer any component or vehicle in the presence of the permanent Eligibility Scrutineer and one other scrutineer at the Ginetta Cars workshop or at a service partners premises. An invited member of the Team may also be present. Removal of components from the car may be required at the Event or at the Ginetta Cars workshop at the discretion of the Eligibility Scrutineer. After thorough scrutineering of the parts, the result will be submitted to the Clerk of the Course.
- 3.6.10 In the case of a breach of the Technical Regulations or a breach of the procedure surrounding the Technical Regulations, any costs associated with scrutineering and/or eligibility inspections (including, but not limited to transportation, checks, inspections, rebuilds, etc.) will be the sole responsibility of the Entrant.
- 3.6.11 The assembly and dismantling of the vehicle(s) are solely the responsibility of the Entrant(s). Reimbursement of expenses for these measures may not be claimed. Exceptions to this may include appeal / protest according to **NCR Chapter 2**.
- 3.6.12 The Championship Organisers will nominate a rolling road dyno truck that may be used to assist the Eligibility Scrutineer. At any time, the Championship Organisers or Eligibility Scrutineer reserve the right to test a vehicle on the nominated rolling road dyno machine and may use any data from the rolling road

dyno machine as guidance and to assist with their determination of eligibility. Competitors / entrants must sign any associated indemnities to allow their car to be tested on the dyno.

- 3.6.13 In the event of a car being dyno tested after a qualifying session or race the driver/Team will be informed by the Eligibility Scrutineer. The car must then be left in Parc Fermé until it is collected by a designated Ginetta / [SRO Motorsport](#) official.

4. CHAMPIONSHIP RACE PENALTIES & JUDICIAL PROCEDURES

In accordance with **NCR Chapter 2** and these Championship regulations.

4.1 INFRINGEMENTS OF TECHNICAL REGULATIONS

4.1.1 Arising from post practice Scrutineering or Judicial Action

Minimum Penalty: The provisions of **NCR Ch.2 App.8 Arts.1.20-1.21.**

4.1.2 Arising from post-race Scrutineering or Judicial Action

Minimum Penalty: The provisions of **NCR Ch.2 App.8 Arts.2.2.a+b.**

For infringements deemed to be of a more serious nature the Clerk of the Course and/or Stewards of the **Event** are to invoke the provisions of **NCR Ch.2 App.8 Art.2.2.c.**

4.1.3 Further penalties may be imposed by the Championship Stewards as outlined within these regulations **and in accordance with NCR Ch.2 App.2 Art.4.**

4.1.4 Infringements of non-technical NCR and these Sporting Regulations issued for the Championship:

As per **NCR Chapter 2** and these Championship Regulations.

4.1.5 Up to a 10 Grid Place Penalty may be applied at a Drivers' future Race, in accordance the **NCR.**

4.2 SPORTING REGULATIONS: JUDICIAL PROCEDURES

4.2.1 Rounds: In accordance with the National Competition Rules and these Championship regulations.

4.2.2 Championship: In accordance with the National Competition Rules and these Championship regulations.

4.2.3 Driving Standards: Breaches of driving standards during practice or race will be dealt with firmly.

4.2.4 The Clerk of the Course may at their discretion, wish to review any evidence in order to assist with their enquiry into an alleged breach of driving standards and accordingly, they may order that the results remain provisional and may take judicial action at a later date.

4.2.5 The Championship Organisers may also within 14 days of the **event** and provided that the results have remained provisional be entitled to request the Championship Stewards to enquire into the matter notwithstanding that the Clerk of the Course and / or the Stewards of the **Event** may or may not have already investigated the incident. The Championship Stewards will be empowered to take further action if they deem it necessary which could include disqualification from **further participation in the Championship.**

4.2.6 Responsibility: It should be noted that the Parent / Legal Guardian or other delegated representative of any competitor in this championship has an obligation to abide by the NCR [**NCR Ch.3 App.4 Art.3** and **NCR Ch.6 App.3 Art.2.10** refers].

4.2.7 Indemnity: In accordance with **NCR Ch.3 App.4 Art.3** Parents/Legal Guardians will be required to sign a special indemnity at each event.

4.2.8 The Championship Coordinator pursuant to **NCR Ch.4 App.1 Art.1.2** and these Championship Regulations in any event may in their discretion refer any Registered Competitor Entrant or Team and in

respect of any dispute or irregularity arising howsoever under these Championship Regulations including all and any amendment of them to the Championship Stewards who after conducting a Hearing shall be empowered to impose any penalty permitted under **NCR Chapter 2, including but not limited to Disqualification from further participation in the Championship.**

4.3 JUDICIAL HEARINGS

4.3.1 If a competitor is involved in a collision or incident, they must not leave the circuit (except where medically evacuated) without the consent of the Clerk of the Course, failing which, any judicial action against or relating to that Entrant / Driver may be heard in their absence.

4.3.2 When attending a judicial hearing, any driver under the age of 18 must be accompanied by a maximum of ONE guardian. Where the driver is entered with the support of a Team Entrant, the guardian must be a Team Representative nominated by that Team Entrant who will attend all judicial proceedings in place the drivers Parent/Legal Guardian.

4.3.3 The Organisers of the Protyre Motorsport Ginetta GT Championship are determined to create a championship which is cleanly fought and with good sporting behaviour prevailing.

Breaches of driving standards will be firmly dealt with. If the Clerk of the Course wishes to view any video evidence and / or data logging evidence in order to assist with their enquiry into a breach of driving standards he may order that the results remain provisional, and they may take judicial action at a later date. However, the use of video evidence and/or data logging evidence in all circumstances is at the sole discretion of the Clerk of the Course.

4.4 ADDITIONAL SPECIFIC CHAMPIONSHIP PENALTIES

4.4.1 In order to maintain standards of conduct (both on and off the track); the Championship Co-ordinator will monitor all conduct and or Officials/Observers reports of adverse behaviour at Events. If any individual is included on such reports, they will receive a written warning from the Organisers that their driving/behaviour is to be specifically observed at future Events. Any adverse reports during this period of observation could result in a Championship Stewards' enquiry, with possible loss of Championship points and Disqualification from further participation in the Championship.

This will include but is not limited or restricted to:

- Overly aggressive or dangerous driving
- Aggressive or threatening behaviour
- Abuse in any form
- Intimidation
- Discrimination
- Obtrusive Behaviour
- Any other action that is deemed to be detrimental to the Championship

4.4.2 When a penalty that generates Motorsport UK Licence Points, in accordance with **NCR Ch.2 App.12** which has been imposed on a competitor by the Clerk of the Course or the Stewards of the Event, a '3x points multiplier' championship penalty will also be incurred, whereby the number of penalty points will be multiplied by three and that number of championship points be deducted from that competitor's championship points total even if this results in a negative score.

When a round takes place outside of the UK and is run under the regulations of the local ASN, a driver will not normally receive points on their Motorsport UK competition licence to accompany a penalty.

4.4.3 Deleted

4.5 BEHAVIOURAL POINTS

4.5.1 Drivers involved in incidents of any kind, or who have been reported for poor sporting behaviour or driving standards, may be awarded Behaviour Points by the Clerk of the Course.

4.5.2 The following is an example of offenses which may result in Behavioural Points issued, it is the decision of the Clerk of the Course on the severity and Points which should be issued:

(a) Misbehaviour.

(b) Pit Lane Speed.

(c) Causing a collision.

4.5.3 Other offences may give rise to Behaviour Points as decided by the Clerk of the Course.

4.5.4 The number of Behavioural Points will be calculated per driver and the following penalties imposed:

(a) A driver with 3 points will receive a 5-place grid penalty.

(b) A driver with 6 points will receive a 10-place grid penalty.

(c) A driver with 9 points will receive a 10-place grid penalty and -10 Championship Points.

(d) A driver with 12 points will receive a 10-place grid penalty and -25 Championship Points.

4.5.5 Behavioural Points can also be issued to Entrants (Teams), the following is an example of offences, it is the decision of the Clerk of the Course on the severity and Points which should be issued:

(a) Warnings

(b) Abusive language or behaviour

Other offences may give rise to Behavioural Points as decided to the Clerk of the Course.

4.5.6 The number of Behavioural Points will be calculated per Entrant (Team) and the following penalties imposed:

(a) An Entrant (Team) with 2 points will receive £100 fine.

(b) An Entrant (Team) with 4 points will receive £500 fine.

(c) An Entrant (Team) with 4 points will receive £1000 fine.

4.6 SOCIAL MEDIA

Social media, including, but not restricted to, Facebook, Instagram, Twitter etc. is a powerful and wide-reaching medium for the expression of views and opinions, and the sharing of photographs and video. As such, competitors should be aware that their conduct on social media regarding the Championship, [SRO Motorsport](#), Ginetta Cars, the BRSCC and its drivers should reflect the impact social media has. If a competitor is considered to have brought the Championship and the BRSCC into disrepute in the opinion of the Championship Co-Ordinator or Stewards, they may be subject to a penalty or disqualification from the Championship. Additionally, competitors are reminded that the Motorsport UK

monitor social media and any remarks that are deemed to bring the sport into disrepute can lead to penalties.

4.6 Deleted

5. TECHNICAL REGULATIONS

5.1 INTRODUCTION

The following Technical Regulations are set out in accordance with the Motorsport UK specified format and it should be clearly understood that if the following texts do not clearly specify that you can do it you should work on the principle that you cannot.

Everything that is not explicitly authorised and anything that is not specified:

- (a) In these regulations,
- (b) In the workshop manual/nomenclature relating to the Ginetta G56 GTP8,
- (c) In any official technical bulletin that may be published,

is strictly forbidden.

The organisers reserve the right to accept an entry from a Competitor using a Vehicle that does not strictly comply with the technical regulation herein. Those competitors will be placed in an invitation class and will not qualify for points, awards or prizes and for those purposes will be ignored.

- 5.1.1 Each Ginetta race car is manufactured to an identical class specification. In the interests of fairness and safety, competitors may not depart from this specification under any circumstances, other than as specified within these regulations.
- 5.1.2 Any issue howsoever touching upon the conformity to the class specification of a car or any component within a car shall be determined definitively by certificate under the authority of Ginetta Cars Ltd including any matter arising as a consequence of any technical or eligibility examination of the car by or on behalf of the Organisers for all purposes under these regulations and the **NCR**.
- 5.1.3 All Ginetta manufactured parts and in particular body panels must be supplied by Ginetta Cars Ltd (or in the case of force majeure a supplier nominated by the Organisers) and fitted in their original position. Entrants Teams and competitors are reminded that the car and all Ginetta parts are the intellectual property of Ginetta and interference with those rights shall be a breach of these Championship Regulations including the Commercial Regulations and without limitation of rights vested in [SRO Motorsport](#) will lead to revocation of Championship Registration.
- 5.1.4 Except as may be permitted expressly by these Regulations or in writing by [SRO Motorsport](#) on behalf of the Organisers no car shall use or have affixed to it any pattern or aftermarket component as part of or in substitution for the class specification of the car and its components.
- 5.1.5 Whilst the [Championship](#) Eligibility Scrutineer is empowered to check all competing vehicles for compliance and has been provided with the data to determine the continuing eligibility of each car, the onus of responsibility for the eligibility of vehicles competing in this Championship, rests with the Competitor. Notwithstanding Championship Regulations **5.1.2** and **5.1.4** in the event of a dispute concerning the compliance of a vehicle with these Regulations the onus is on the Competitor to satisfy the Organisers with regard to such compliance and NOT the Organisers to prove non-compliance.
- 5.1.6 Where it is suspected that a component or structure fitted to the competing vehicle may render the vehicle ineligible under these regulations the component or access to the component will be sealed on behalf of the Organisers by the [Championship](#) Eligibility Scrutineer for subsequent examination as directed by the Organisers. Where ineligibility is subsequently proven all points accrued by the competitor from and including the date of sealing the said component to the date of examination shall

be forfeit in addition to any other penalty or penalties applied by the Organisers under or pursuant to these Regulations.

- 5.1.7 Where costs are incurred as a result of any eligibility check conducted either by the [Championship Eligibility Scrutineer](#) or the Championship Organisers these will be borne by the competitor and Championship Registration shall be suspended until such time as those fees have been paid as cleared funds regardless of any Judicial Appeal arising out of the eligibility examination.
- 5.1.8 As a method of control, any component on a competitor's car may be removed by the competitor at the request of the [Championship Eligibility Scrutineer](#) and exchanged for a similar component from the car of another competitor, or provided by the Championship Organisers. This includes the ECU. Whilst efforts will be made to ensure that the condition of the exchanged parts is similar, responsibility for the care of exchanged components lies with the recipient. Exchanged components may be returned to their original owners on completion of the race.
- 5.1.9 Any infringement of these Technical Regulations will render the competitor liable without limitation to penalties as provided by these Regulations including for the avoidance of doubt under the Commercial Regulations.
- 5.1.10 Competitors will be required to complete an online component seals log form for each of the transaxle and engine. Any changes to components will require updated forms to be completed and submitted to the [Championship Eligibility Scrutineer](#) with prior permission.
- 5.1.11 Whilst Ginetta will endeavour to inform Competitors of any changes of components or part numbers they reserve the right to fit updated components during the life of these Regulations.
- 5.1.12 Lubricants – All cars competing within the Championship must use the lubricants specified and supplied by Ginetta with no additives of any kind, and be able to provide a minimum sample of lubricant from each component as detailed below:
 Engine - Ginetta Tech by Millers 10w60 Engine Oil – G55-N0071.
 Transaxle – Millers Oil 75w90 LS Gear Oil – G55-N0072 75w90.
 Each component must be able to produce a minimum sample of the following amounts:
 Engine: 3.5 litres.
[Transaxle](#): 1 litre.
- 5.1.13 Oil samples will be taken in accordance with **NCR Ch.8 App.2 Art.8** and analysed throughout the season in order to police this regulation.
- 5.1.14 Failure to comply with **5.1.12** will result in a technical non-compliance being issued and will be dealt with in accordance with Article **5.1** of these championship regulations.

5.2 GENERAL DESCRIPTION

- 5.2.1 The Protyre Motorsport Ginetta GT Championship is a 'one make' race series for Competitors participating in Ginetta G56 GTP8 race car as specified herein.
- 5.2.2 The current version of the Workshop Manual / Nomenclature for the Ginetta G56 GTP8 Car incorporating all clarifications amendments and details of updated components shall remain the only active version of the document and is available from Ginetta Cars Ltd on request. All Entrants and Teams and Competitors warrant and undertake conformity with the Workshop Manual and Nomenclature. Non-conformity will be penalised as provided by these Regulations.

5.2.3 The parts used to build a Ginetta G56 GTP8 Car are described in the document named 'Nomenclature'. These parts are divided into 3 categories:

(a) No modifications are permitted. Parts in this category must remain in their original location and fulfil the function/s for which they were originally designed.

(b) Only such modifications as specified in the regulations or the Ginetta G56 GTP8 nomenclature are permitted.

(c) The part is considered to be unrestricted on the express condition that the function for which it was originally designed is not deviated from that it does not fulfil any additional function and that it is located in the same place as the original part.

5.2.4 Any query in respect of any technical matter arising out of or touching upon these Regulations must be put in writing to the Organisers for referral to the [Championship](#) Eligibility Scrutineer and / or [SRO Motorsport](#). The only clarifications, rulings or permissions under these Regulations that will be acknowledged by the Organisers must be substantiated by the production on demand of written confirmation of such clarification's rulings or permissions. Entrants Team and Competitors are referred to in **5.1.2** of these Regulations.

5.2.5 Examination of Vehicles

The organisers (in addition to any other powers they may have under these Regulations) reserve the right before or after any race in the Championship/series to designate any one or more of the competing cars for special eligibility scrutineering. Upon such election being made the competitor shall immediately place the car under the control of the organisers and be deemed to have permitted all such scrutineering, examination and testing as the organisers may responsibly require to undertake. The organisers have the right to:

- a) Examine the car at the circuit for such period as they may reasonably require, take fuel and/or other samples, and/or
- b) Retain the car for detailed examination at premises chosen by the organisers. If the organisers elect to retain the car, they shall make it available for collection by the competitor at least seven days prior to the qualification session for the next race in the Championship/series unless the car is found to be in breach of these regulations and/or
- c) Tests to establish the power output of any car may be carried out by the organisers or their representatives. Such power testing will be carried out using any test equipment deemed suitable by the organisers.
- d) Seal the car and its components in such a manner as they may choose and require the competitor at their own expense to present the car at any other premises chosen by the organisers for detailed examination within a specified period and/or remove the car by transporter at expense to the competitor to an appointed location. The competitor will be advised in writing of the time, date and location of the subsequent testing or eligibility examination. The competitor will be liable to cover all relevant and receipted expenses costs in relation to the required personnel in attendance for any such vehicle inspection, as well as for any costs related to removal, dismantling, refitting of any parts as requested as part of the process. The organisers accept no liability for any parts that may be rendered unserviceable due to the inspection process.
- e) The stripping of an engine or any required component will be undertaken by the competitor and/or mechanic/technician nominated by the competitor under the direction of the

Championship Eligibility Scrutineer or another nominated Motorsport UK Scrutineer. The competitor will be liable to cover all relevant and receipted expenses costs in relation to the required personnel in attendance for any such vehicle inspection, as well as for any costs related to removal, dismantling, refitting of any parts as requested as part of the process. The organisers accept no liability for any parts that may be rendered unserviceable due to the inspection process.

The organisers reserve the right to re-inspect vehicles at any time during the course of the season.

Competitors will be personally and solely responsible for ensuring that their cars comply with their registration details and with these regulations for each event at which they are entered. Failure to comply in either respect will be a breach of these regulations. Queries concerning eligibility should be referred in writing to the Organisers/Championship/Series Eligibility Scrutineer at least seven days prior to an event entered, to permit a ruling in advance of any **event** at which it is intended to compete.

- 5.2.6 The colour scheme for any car is free but the car must be presented in a good, clean condition and any damage sustained must be made cosmetically good to the approval of the Eligibility Scrutineer before the next event. Failure to do so will be considered non-compliant.
- 5.2.7 Cars must have all Championship decals affixed as per the issued decal sheet. The Championship Eligibility Scrutineer may deem any cars not carrying all decals to be non-compliant.

5.3 SAFETY REQUIREMENTS

5.3.1 The Ginetta G56 GTP8 race car is manufactured to comply with the following safety requirements of **NCR Chapter 7** and all which must be retained:

- (a) **NCR Ch.7 App.3** Roll Over Protection System (ROPS) - Motorsport UK approved to applicable FIA standards with side and rear safety protection bars, certificate number 2238.
- (b) **NCR Ch.7 App.7 Art.9.1** FIA homologated six-point safety harness. Safety Harness Homologated to 8853-2016 six point.
- (c) **NCR Ch.7 App.6 Art.1** Plumbed in current FIA homologated fire extinguisher system. This system must be in the 'armed' condition (i.e., be capable of being operated without the removal of any safety device) at all times whilst competing or practicing. The fire extinguisher cannot be disarmed in any Parc Fermé area without the specific permission of the **Championship** Eligibility Scrutineer. Any system found to be incapable of being operated, by virtue of the imposition of a safety device (eg.pin) having been made whilst the vehicle is either competing or in Parc Ferme, will be subject to report to the Clerk of the Course for possible penalisation as an offence against Safety Regulations.

The fire extinguisher must be serviced every two years by the manufacturer or the manufacturers agent to remain within its homologation. For the avoidance of doubt this means that only the above applies and not any alternative service facility or persons.

- (d) **NCR Ch.7 App.7 Art.2** Be fitted with a seat that is FIA Homologated to either FIA 8855-1999, FIA 8862-2009 or FIA 8855-2021, and in date and complying with **NCR Ch.7 App.7 Art.2**.
- (e) **NCR Ch.7 App.5 Art.6** Two fog lamps which in the Ginetta are integral within the rear light clusters.
- (f) **NCR Ch.7 App.4 Art.2** Internal fuel filler that can be positively closed.
- (g) **NCR Ch.7 App.5 Art.5** External Circuit Breaker.

(h) NCR Ch.7 App.7 Art.4 Head restraint – as part of mandatory FIA approved seat.

(i) G137Q-0001NP.00 driver net – mandatory fitment.

- 5.3.2 The attention of all competitors is drawn to **NCR Chapter 9** relating to overalls, crash helmet and visors.
- 5.3.3 The use of an FIA homologated FHR, (head and neck support systems), is compulsory. The helmet manufacturer must certify the tether anchorages and their mounting.
- 5.3.4 For clarification on clothing standards and for a list of approved helmets refer to the FIA website, www.fia.com.
- 5.3.5 Any padding on the roll cage must comply with FIA standard 8857-2001.
- 5.3.6 Roll cage padding (complying with FIA standard 8857-2001) must be used on the sections of roll cage as shown in the diagram below:

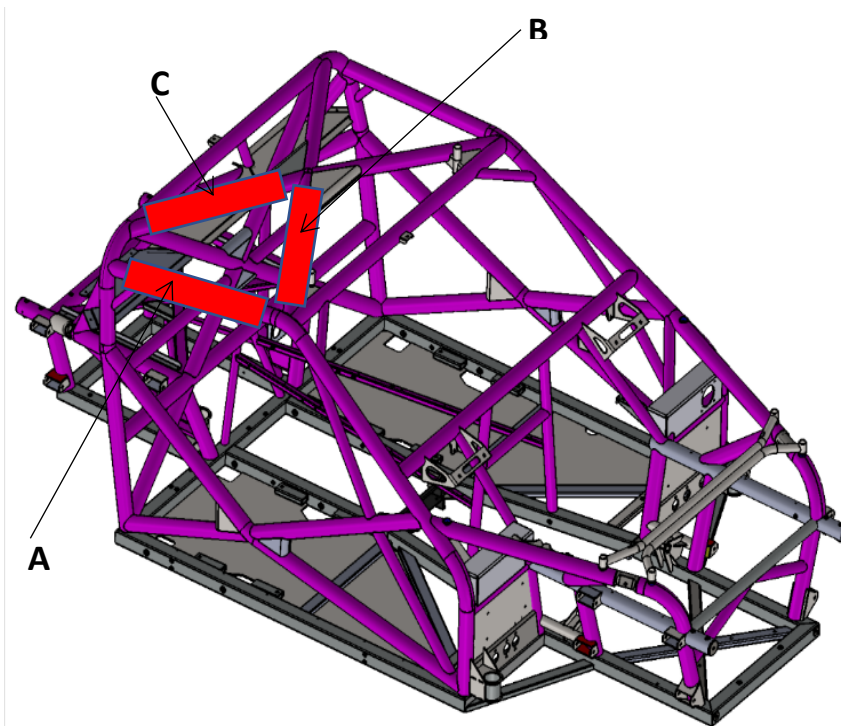

Lengths of padding required:

- A – 500mm
- B – 450mm
- C – 500mm

5.4 GENERAL TECHNICAL REQUIREMENTS & EXCEPTIONS

The Ginetta G56 GTP8 race car is built to comply with the provisions of **Chapter 7** (all vehicles) and **Chapter 12 Appendix 13** (race vehicles) of the **NCR**. Competitors are reminded that a catch tank must be fitted and that the location of the vehicle towing eyes should be suitably marked.

From time to time, it will be necessary to approve alternative equivalent components. Only components approved as alternatives and published as such by the Championship Organisers and / or their appointed representatives in official amendments to these regulations are eligible for the Ginetta GT Championship.

In case of force majeure, Ginetta Cars may at any time approve alternative components. Competitors will be notified of any changes to the regulations via a published bulletin. If alternative components are to be used, these must first be approved by the Eligibility Scrutineer, and be declared in writing at the time the component is fitted when the car is presented for scrutineering. The substitute component must then be replaced as soon as the correct part becomes available.

All additional equipment fitted to cars in addition to that supplied by Ginetta Cars must be removed completely for any official Practice and Qualifying and Race sessions. For example, if a radio kit is fitted for training purposes this must be fully removed as opposed to just disconnected.

5.4.1 Towing Eyes

Towing eyes must be fitted for all Official sessions, including Pre-Event Testing, Qualifying and Regulations. G40-R0226.

5.5 CHASSIS

5.5.1 The Ginetta G56 GTP8 car and chassis is manufactured to a standard specification and may not be altered. All chassis repair work must be undertaken only under the control and approval of Ginetta Cars Ltd. Breach of this Regulation may result in evocation of Registration(s).

5.6 BODYWORK

5.6.1 The Ginetta G56 GTP8 race car body is manufactured to a standard specification. All body parts must be sourced and supplied exclusively through Ginetta Cars Ltd. Minor fibreglass repairs may be undertaken by the competitor provided that the body profile is not altered in any way, and the material used is of the same construction as the original component. However, the Organisers reserve the right to reject any such repairs whether in the interests of safety technical conformity or Championship aesthetic and to require the Entrant Team or Competitor to substitute the damaged repaired panel with a new panel sourced in accordance with this Regulation.

5.6.2 Additional ventilation holes may not be cut into the bodywork unless written consent has been given by Ginetta Cars Ltd and approved by the Eligibility Scrutineer. This includes internal and external bodywork.

5.6.3 A bodywork template/profile tool may be used by the Organisers at any time including but not exclusively at scrutineering to ensure that original shape and car profile is retained. This includes any apertures in the bodywork. No extra panelling either under floor or around the wheel arch area is permitted. The presentation of vehicle bodywork and repairs must be deemed acceptable by Ginetta Cars Ltd and the Championship Organisers in the interest of all cars being presented in a way representative of the Ginetta marque. It is not permitted to cover bodywork apertures and joint lines with adhesive tapes unless authorised by the Eligibility Scrutineer as a short-term repair.

5.6.4 It is not permitted to cover bodywork apertures and joint lines with adhesive tapes unless authorised by the [Championship](#) Eligibility Scrutineer as a short-term repair. The only exception to this is the application of adhesive tape to cover a portion of the radiator aperture mesh but ensuring not to cover the power steering cooler. The tape must adhere to the mesh not the bodywork so as to not create an aerodynamic advantage.

- 5.6.5 The mesh and carbon fibre sill front end covers (Mesh G114B-0191NA.00 & G114B-0193NA.00 carbon fibre G114B-0197NP.00 & G114B-0199NP.00) must be fitted to both left and right hand sides of the vehicle. Rear covers (G55- B0261/B0262) must also be fitted both covers must be supplied by Ginetta Cars. Additional covers may be added but must be checked by the [Championship Eligibility Scrutineer](#) before permitted for use.
- 5.6.6 Door mirrors (G55-B0507 & G55-B0508) must be fitted and remain in their original positions. It is permissible to use an alternative central rear-view mirror to the one supplied by Ginetta Cars.
- 5.6.7 The driver's seat is fixed and installed in accordance with **FIA Appendix J Art 253. 16** (G40-Q0110). Drivers may change their seat only with written confirmation from the Championship Organisers. A FIA Homologated and in date seat must be fitted.
- 5.6.8 A standard front screen as supplied by Ginetta Cars Ltd must be fitted. (G123B-0064NP.00)
- 5.6.9 The rear bumper vents must be covered with mesh as supplied by Ginetta cars. Alternative mesh may not be used. G55-B0138 & G55-B0139
- 5.6.10 The front bumper lower metal guard must remain positioned directly to the front bumper. The front bumper should be fitted directly to the crash box.
- 5.6.11 The Ginetta badge must remain attached and visible on the front bonnet at all times.

5.7 REAR WING

- 5.7.1 The Ginetta GTP8 race car must only use a rear wing aero kit as supplied by Ginetta Cars Ltd. All components of the rear wing kit must remain as standard and as supplied by Ginetta Cars Ltd and may not be altered in any way. No additional structures other than those permitted or mandated by Ginetta Cars Ltd are allowed. (G50-B0115 & G50-B0116)
- 5.7.2 The position angle and height of the rear wing is fixed for mounting of the wing stay to wing box positions. A template may be used to certify that no modifications have been made to any part of the rear wing kit.

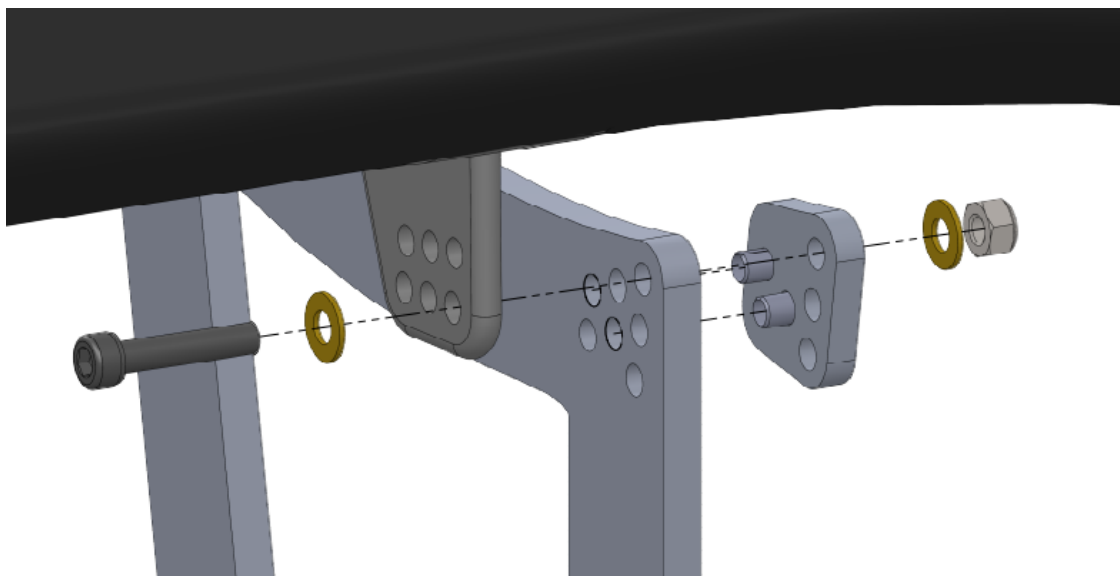

- 5.7.3 The fitment of a rear wing gurney ([G55-B0124](#)) is mandatory and must not be modified in any way from its standard size and shape.

5.8 PERMITTED ENGINES

- 5.8.1 The following specifications are for information only and are not intended to and do not infer modification is in anyway allowed.
- 5.8.2 The Ginetta GTP8 Car is supplied with a current Ginetta Cars Ltd specification GM 6.2 litre LS3 V8 engine, fitted with ancillaries built by Ginetta Cars Ltd and sealed by Ginetta Cars Ltd using Ginetta specific seals. Ginetta Cars Ltd will notify the Entrant of the location of the applied seals and will exclusively maintain a record of the locations and the seal numbers. The engine seals must remain intact and undamaged for the engine to be eligible to take part in official testing qualifying or racing events. It is the responsibility of the Competitor to ensure the security of the seals. Seals can only be removed by the [Championship](#) Eligibility Scrutineer or approved agent of [SRO Motorsport](#). All broken Seals are recorded and noted by the Championship Organiser and in the event of any seal being broken or in the absolute opinion of the Organisers having the appearance of having been tampered with then the engine shall be deemed by the Organisers ineligible in any event and shall be subject to inspection at exclusive cost to the Competitor payable as a debt. All relevant Championship Registrations shall be suspended until such time as the cost of inspection under this Regulation has been paid as cleared funds as directed by the Organisers.
- 5.8.3 If the engine is damaged or worn it must be returned to Ginetta Cars for exchange or repair by Ginetta Cars Ltd at the competitor's cost. Any maintenance to the engine in an area not covered by the Seals must use original parts for this engine and which must be sourced exclusively from Ginetta Cars Ltd. In any dispute the part in question will be compared to the relevant part and/or drawing held by Ginetta Cars Ltd. All relevant Championship Registrations shall be suspended until such time as the cost of repair or replacement as the case may be under this Regulation has been paid to Ginetta Cars Ltd as cleared funds.
- 5.8.4 Engine Control Unit. (ECU) The cars are fitted with a MOTEC M150 ECU. These are fitted with a bespoke Fuel and Ignition map and Engine run data which are Password protected. The ECU must not be tampered with in any way. The ECU can be interrogated at any time during a [Event](#) at the request of the Organisers by the [Championship](#) Eligibility Scrutineer or approved [SRO Motorsport](#) agent. The Championship Organisers reserve the right to exchange any Competitor's ECU with an Official Series spare.
- [A Motorsport UK seal must be attached to the ECU following confirmation from Ginetta Cars that the latest map is installed. The Motorsport UK seal number must be recorded on the Formstack system in the same way as engine seal numbers etc. are recorded. This will then be the only ECU permitted to be used in the championship in that specific car. The ECU can only be changed with written permission from the Licensed Eligibility Scrutineer or the Championship Coordinator.](#)
- 5.8.5 Engine Wiring Loom. This must remain as supplied by Ginetta Cars Ltd with no modifications permitted. (G114L-0011NA.00)
- 5.8.6 Manifolds. It is permissible to use only inlet and exhaust manifolds as per G114E-0133NP.00, G114F-0003NA.00 & G114F-0005NA.00 List as supplied by Ginetta Cars Ltd. Polishing abrasive cleaning or otherwise altering the manifolds internally is prohibited.
- 5.8.7 Catalytic Converters. A catalytic converter as supplied exclusively by Ginetta Cars Ltd must be fitted to each exhaust and must be working at all times and remain unmodified. Tests will be carried out to ensure compliance. G114F-0007NA.00.
- 5.8.8 Air Filter. This must be fitted at all times and remain as supplied by Ginetta Cars Ltd. G114E-0075NP.00.

- 5.8.9 Fuel Pressure. The fuel pressure regulator (G55-M0104) supplied with the car is the only eligible type. The fuel pressure must be 4.0 BAR +or-0.2 BAR. The fuel pressure will be checked regularly to ensure compliance.
- 5.8.10 Spark Plugs. LS3 V8 engines are supplied with ACDelco 12621258 spark plugs. These can be replaced using NGK BPR6EFIX-10 (GIN-LMP3-E0253) plugs supplied by Ginetta Cars Ltd. Only these alternative spark plugs are eligible in the Championship.

5.9 SUSPENSIONS

- 5.9.1 The standard suspension components and configuration as supplied by Ginetta Cars Ltd must remain unaltered except as specified below.
- 5.9.2 Front and Rear anti-roll bars must remain standard as supplied by Ginetta Cars Ltd and remain in the standard locations and standard material T45 35/2mm. Anti-roll bar stiffness adjustment is free within the range provided. It is permissible for one of the operating linkage rods to be removed.
- Front anti roll bar (G50-C0115)
 - Rear anti roll bar (G114C-0241NA.00)
- 5.9.3 **Ground clearance**, front and rear must be kept within the tolerance below:
- Front – minimum 70mm
 - Rear – minimum 80mm

The organisers reserve the absolute right to amend the minimum **ground clearance** measurements listed above by means of a Championship Bulletin at any time during the Championship.

Specific points of where **ground clearance** will be measured;

- Front - the measurement must be taken from the highlighted area in red on the image below between the front axles. **Specifically, the boundary for this highlighted area is formed by a straight line between fasteners pictured.** Fouling on the floor, bodywork or fasteners before the marked area is not a fail.
- Rear - the measurement must be taken from the highlighted area in red on the image below between the rear axles. The area extends from the rear of the skid block to the start of the slope of the diffuser and is the same width as the skid block.

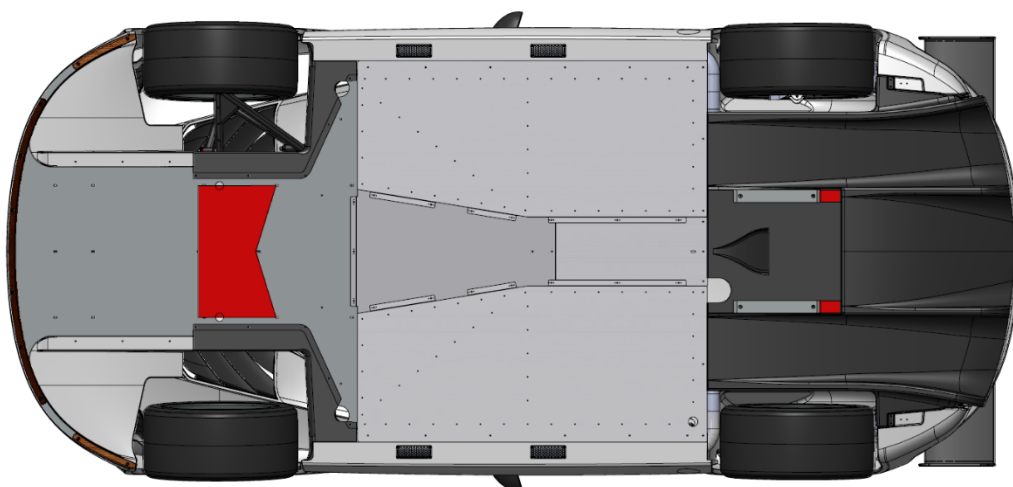

- 5.9.4 At each Championship round the **Championship** Eligibility Scrutineer will designate a location where all **ground clearance** measurements shall take place.
- 5.9.5 These measurements shall be applied with the driver on board and with tyres normally inflated. If the **ground clearance** is measured at the end of an on-track session the tyre pressures must be set at 1.8

bar.

5.9.6 The front and rear wheel camber angle may be adjusted by means of standard size shims. The only permitted shims are those supplied by Ginetta Cars Ltd.

5.9.7 As standard the shims are supplied in the following thicknesses: - check

- 2.00mm ([G50-C0011](#))
- 3.00mm ([G50-C0012](#))
- 5.00mm ([G50-C0013](#))

5.9.8 The front and rear wheel camber may be adjusted to a minimum by use of a single 2.00 mm thick shim per upright and to a maximum of 15.00 mm per upright using a combination of the standard shims.

5.9.9 The front and rear wheel toe in/out may be adjusted within standard limits and with no modification.

- **Front Toe Shims**

- [0.1 mm \(G114C-0189NP.05\)](#)
- [0.3 mm \(G114C-0189NP.04\)](#)
- [0.5 mm \(G114C-0189NP.03\)](#)
- [1 mm \(G114C-0189NP.02\)](#)
- [2 mm \(G114C-0189NP.01\)](#)

- **Rear Toe Shims**

- [0.1 mm \(G114C-0155NP.01\)](#)
- [0.3 mm \(G114C-0155NP.02\)](#)
- [0.5 mm \(G114C-0155NP.03\)](#)
- [1 mm \(G114C-0155NP.04\)](#)
- [2 mm \(G114C-0155NP.05\)](#)

5.9.10 Springs. The only permitted springs are the ones as outlined below and supplied within the range as detailed by Ginetta Cars LTD and must be fitted to the front or rear of the car as described.

5.9.11 Spring rate and part numbers must be as follows:

- [Front – 1100 lb \(G55-C0094\)](#)
- [Rear – 900 lb \(G50-900X10X46\)](#)

5.9.12 If the distinguishing marks become illegible the component may be re-authenticated providing an audit trail and compliance with the component specification can be demonstrated.

5.9.13 Shock absorbers as specified as part number G137C-0001NP.00 (front) and G137C-0002NP.00 (rear) supplied exclusively by Ginetta Cars Ltd. Damper traces detailing the required specification can be supplied by Ginetta Cars Ltd.

5.9.14 The standard track and wheelbase dimensions must be retained.

5.9.15 Wishbones must remain in standard specification and only be fitted with approved associated spacers.

5.9.16 Toe link must remain standard with no modification.

5.10 TRANSMISSIONS / FINAL DRIVE

5.10.1 The Ginetta GTP8 race car must retain the Xtrac Transaxle gearbox (G114G-0001NA.00). It is the competitor's responsibility to ensure that the following prescribed gear ratios are retained at all times during competition: 1st 2.846, 2nd 2.230, 3rd 1.800, 4th 1.500, 5th 1:278, 6th 1.087 Calculated including the drop gear ratio (total transmission ratio).

5.10.2 The sealed Transaxle may only be rebuilt by Ginetta Cars Ltd. Ginetta Cars Ltd will notify the Entrant of the location of the applied seals and will exclusively maintain a record of the locations and the seal numbers. The seals must remain intact and undamaged for the Gearbox and / or differential to be eligible to take part in official testing qualifying or racing events. It is the responsibility of the Competitor to

ensure the security of the seals. Seals can only be removed by the [Championship](#) Eligibility Scrutineer or approved agent of Ginetta Cars Ltd. All broken Seals are recorded and noted by the Championship Organiser and in the event of any seal being broken or in the absolute opinion of the Organisers having the appearance of having been tampered with then the relevant component shall be deemed by the Organisers ineligible in any event and shall be subject to inspection at exclusive cost to the Competitor payable as a debt. All relevant Championship Registrations shall be suspended until such time as the cost of inspection under this Regulation has been paid as cleared funds as directed by the Organisers

5.10.3 The clutch as supplied by Ginetta Cars Ltd must be retained in its original form.

5.10.4 Clutch master cylinder bore size 0.625 part number G137I-0047NP.01 may be fitted as an upgrade to the standard component.

5.10.5 Flywheel. The flywheel must remain as supplied by Ginetta Cars Ltd. The weight of any flywheel must be no less than 2.3kg and must not be modified in any way.

5.11 INDUCTION SYSTEM

5.11.1 The standard induction system as specified from time to time by and as supplied exclusively by Ginetta Cars Ltd and consisting of a single throttle body is the only permitted induction system. No modification to this system or inclusion of additional structures between the air box and throttle body assembly is permissible. The throttle body housing shall not be modified internally in any way. No polishing or re-profiling is permitted. The external throttle linkage including the throttle return spring and the fly by wire control unit may not be reworked or modified in any way. Air filter (G114E-0075NP.00) must be used supplied as standard by Ginetta Cars Ltd. No modification is permissible to this system whatsoever. If any component of the induction system is found ineligible then Championship Penalties under these Regulations including the Commercial Regulations will be applied by the Organisers.

5.11.2 The engine will be fitted with a sealed 44 mm inlet restrictor (G114E-0067NP.07) which must be installed with the supplied O ring.

5.12 ELECTRICS

5.12.1 Battery must remain as supplied by Ginetta Cars:

[30A \(GIN-LMP3-L0157\). Using the following parts:](#)

- [G55 GT4 Battery Mount Adaptor Assembly G114A-0219NA.00](#)
- [G55 GT4 2021 Battery Strap G114A-0181NP.00](#)
- [Battery Cover 30A G137B-0223NP.00](#)

[or optional 60A \(G55-L0343\). Using the following parts:](#)

- [G55 GT4 Battery Mount Adaptor Endurance Assembly G114A-0221NA.00](#)
- [G55 GT4 Endurance Battery Strap G114A-0215NP.00](#)
- [G55 GT4 2021 Battery Cover G114R-0101NP.00](#)

The original location of the battery must be retained utilising the standard mountings. Terminals must be insulated. In compliance with **NCR Ch.7 App.5 Art.1.5** the battery earth lead should be identified by a yellow marking.

5.12.2 The coil pack and HT leads (GIN-LMP3-E0138 & GIN-LMP3-E0241) must remain standard and in their original location.

- 5.12.3 The fitting of additional instrumentation is not permitted unless under regulation **5.12.5**.
- 5.12.4 The standard Motec data acquisition system is the only permitted device and must remain set to standard configuration as supplied with the Ginetta G56 GTP8 Car. No additional connections may be made to the ECU whatsoever.
- 5.12.5 As a routine part of eligibility control procedures it may be called upon by either the Championship Organisers or [Championship Eligibility Scrutineer](#) to make available all acquired data from the above detailed equipment at any point for the purpose of collecting engine performance data during either race or qualifying sessions and during official test sessions / [SRO Motorsport](#) organised sessions. For this purpose the ECU download point must remain in its standard location. No additional connections whatsoever shall be made to the ECU as and except as supplied by Ginetta Cars Ltd.
- 5.12.6 The Championship Organisers reserve the right to download and access all data at any time including but not exclusively during race or qualifying sessions and during official test sessions / [SRO Motorsport](#) organised sessions. Entrants and competitors shall make the car including but not exclusively the ECU accessible to the Organisers forthwith on request for examination and if desired data capture.
- 5.12.7 Any competitor may be required by the Organisers to run additional sensors at any time. It is at the sole discretion of the Organisers acting through the [Championship Eligibility Scrutineer](#) as to which cars must run any additional sensors.
- 5.12.8 The 12-volt standard alternator as specified from time to time by Ginetta Cars Ltd must be fitted. The minimum output of the alternator must remain as standard at all times. (G114E-0121NP.00)
- 5.12.9 The starter motor must remain standard as supplied by Ginetta Cars Ltd (GIN-LMP3-E0278)
- 5.12.10 Cars must be fitted with model-standard Ginetta imitation light pod with clear lenses.
- 5.12.11 Cars must be fitted with the current Ginetta Cars Ltd specification rear lights including LED brake lights fog lights and indicators.
- 5.12.12 Steering angle logging kits must be fitted (G55-L0270).
- 5.12.13 The Motec Power Distribution Module and control panel keypad must be fitted, with the associated wiring loom, G123L-0049NA.00.
- [5.12.14 No connection for battery boosting or starting aid equipment \(such as Anderson connector\) shall be installed within the cockpit. Only Ginetta standard externally mounted Anderson kits are permitted for use.](#)

5.12 COOLING SYSTEM

- 5.12.1 The standard layout of the cooling system must be as issued by Ginetta cars LTD. The radiator (G114P-0039NP.00) must be standard and remain in its original location.
- 5.12.2 The thermostat must remain fitted and cannot be exchanged.
- 5.12.3 It is permitted to replace the standard radiator cap with a motorsport type radiator cap of the same fitting. Max pressure of the cap must not exceed 25psi. These must be the same specification as the component G114P-0071NP.00.
- 5.12.4 The transaxle cooler G50-N0014 must remain as standard and unmodified, along with the pump and associated pipework

5.12.5 No other modifications than those referred to above are permissible.

5.12.6 Air conditioning systems must remain complete and in standard configuration, including all belts, pipework, pump and condenser. It is not a requirement for the system to be gassed.

5.13 BRAKES

5.13.1 The standard braking system as supplied for the Championship exclusively by Ginetta Cars Ltd must be retained thus:

- **Front discs:**

Ferrous vented discs 378mm o/dia x 32mm thick
G50-I0057 (right-hand) and G50-I0058 (left-hand)

- **Rear discs:**

Ferrous vented discs 355mm o/dia x 34mm thick with 8 x grooves per side G112I-0016RP.00 (right-hand) and G112I-0015LP.00 (left-hand)

- **Front Calipers:**

Alcon 6 pot calipers
G50-I0068 (right-hand), G50-I0063 (left-hand)

- **Rear Calipers:**

Alcon 4 pot calipers:
G114I-0097LP.00 (left-hand) and G114I-0098RP.00 (right-hand).

There are NO permitted modifications to the above.

Brake master cylinder pairs must be of the same make, model, size and supplied by Ginetta Cars. The only permitted brake master cylinders are:

AP

Front - 0.70" - G137I-0047NP.02
Rear - 0.812" - G137I-0047NP.03

Alcon

Front – 0.70" - G109I-0057NP.00
Rear – 0.812" - G112I-0029NP.00

5.13.2 All brake parts must be supplied exclusively through Ginetta Cars Ltd and must not be modified in any way.

5.13.3 Brake lines must remain as standard supplied by Ginetta Cars Ltd and in the manufacturer's layout.

5.13.4 Brake bias may be altered using the standard balance bar supplied by Ginetta Cars Ltd.

5.13.5 It is not permitted to direct air by means of ducting to the braking system unless previously advised in writing by Ginetta Cars Ltd as an approved system.

5.13.6 Discs and Calipers must remain as supplied by Ginetta Cars. There are NO permitted modifications.

5.13.7 Brake discs must retain a minimum thickness of at least 30mm on any part of the disc surface that interfaces the brake pad at all times.

5.13.8 Brake pads must be supplied by Ginetta Cars Ltd and are marked accordingly, and be G55-I0004 (Front) & G114I-0099NP.00 (Rear). In the event of an eligibility dispute reference will be made to Performance Friction who will decide if the disputed component is authentic and shall be definitive.

5.13.9 The use of the following Brake Pads and friction material is mandatory:

- Front: Performance Friction 7790.11.25.54 Part No G55-I0004
- Rear: Performance Friction 7700.332.20.44 Part No G114I-0099NP.00

5.13.10 If an alternative type of brake pad is made available drivers will be notified by official bulletin.

5.14 WHEELS

5.14.1 The standard wheels of size 18" x 11" as supplied by Ginetta Cars Ltd (G50-J0001) must be used on the all-axle uprights and may not be modified or substituted for others.

5.11.2 The use of wheel spacers or other wheel spacing mechanism is not permissible.

5.15 TYRES

5.15.1 Tyre Allocation Plan:

ROUNDS	VENUE	DATES	TYRE ALLOCATION
1,2	Silverstone	25/26 April	6 NEW
3,4,5	Oulton Park	23/25 May	4 NEW, 2 USED
6,7,8,9	Croft	27/28 June	6 NEW, 2 USED
10,11	Snetterton	15/16 August	4 NEW, 2 USED
12,13,14	Donington Park	05/06 September	4 NEW, 2 USED
15,16	Brands Hatch	26/27 September	4 NEW, 2 USED

5.15.2 The intention of these regulations is:

- To contain costs by limiting the number of tyres which can be purchased on behalf of any one driver during the series.
- To limit the number of tyres used per car/driver per complete event.
- To prohibit the use of any method of raising the temperature of tyres by adding heat artificially.
- To prohibit the application of any material to alter the standard performance of the tyres.
- Any attempt whatsoever to circumvent these intentions or any fraudulent attempt to deface re-mark counterfeit or otherwise circumvent the unique tyre numbering system will automatically be the subject of a report to the Clerk of the Course and / or Championship Stewards for the application of penalties under these Regulations including revocation of all relevant Registrations.

5.15.3 The only permitted dry tyres for use in this Championship is as follows: Pirelli 280/660-18 (SLICKDHG).

5.15.4 The maximum number of tyres available to each car for use during the Championship season will be limited to 26 for all cars in accordance with the Tyre Nomination Plan above **5.15.1**. These tyres must be used in all official Qualifying sessions and races and must be nominated during the season as described in **5.16.2**.

5.15.5 The only permitted wet tyres for use in this Championship are Pirelli 280/660-18 (RAINWHB). These tyres do not have to be included as part of the 6 tyres that are presented at scrutineering. These tyres must be supplied by the designated tyre supplier Protyre Motorsport. The number of wet specification tyres for use in the G56 GTP8 car in the Protyre Motorsport Ginetta GT Championship is not restricted.

5.15.6 It shall be the sole responsibility of the Drivers/Entrants to judge whether the track is wet enough to justify the use of wet weather tyres.

5.15.7 The Clerk of the Course will not judge whether the track is wet enough to justify the use of wet weather tyres.

- 5.15.8 Wet tyres may not be used in conjunction with dry tyres.
- 5.15.9 The 6 tyres allocated for use at the first event of the season must be “brand new”, (A tyre can be deemed to be brand new if it has not had any use on a vehicle) when the car is presented for Scrutineering prior to the first on track session on the Saturday at the start of the event. These tyres must be purchased from the designated tyre supplier on the same weekend they are due to be used. It is the competitor’s responsibility to ensure the designated tyre supplier receives a set of rims in good time, to allow the tyres to be fitted prior to the tyres being released at the start of the event.
- 5.15.10 The six new tyres used at round one will be suitably marked and logged and the four brand new and two carry over used tyres for subsequent rounds must then be presented on the car for use at the following event. All tyres must be logged via the Tyre Nomination Form which can be found on; <https://hub.ginetta.com/>
- 5.15.11 In the occurrence that any damage to the race set of tyres makes participation impossible, it will be allowed to substitute in brand new tyres. Substitute tyres may only be fitted with the express permission of the **Championship** Eligibility Scrutineer in consultation with the Championship Coordinator who will need to be notified when the tyres are fitted, regardless of when this occurs the only reason a competitor may utilise a spare tyre is through damage to one of the four nominated tyres.
- 5.15.12 Once fitted, the replacement tyre must then be used as part of the race set for the remainder of the **event** and any following **event** they are required as detailed in **5.15.1**.
- 5.15.13 During qualifying and races, it is permissible to have available in the pit-lane, the other two nominated tyres to be changed in the event of damage occurring during the sessions and wet tyres.
- 5.15.14 If a competitor joins the Championship part way through the season or for a single round, they can nominate 6 brand new tyres from their first round and then following the tyre allocation plan as listed in **5.15.1**.
- 5.15.15 Bar-coding and / or permanent paint marking will be used to control tyre use. It is the competitor’s responsibility to ensure that all tyres are marked before use and logged by the series coordinator and/or **Championship** Eligibility Scrutineer.
- 5.15.16 All tyres must be supplied by Protyre Motorsport. Tyres will be marked accordingly to certify that they have been supplied by one of these sources.
- 5.15.17 Tyre location on the G56 GTP8 Car must remain standard throughout any qualifying session i.e. it is not permissible to move tyre location across an axle or front to back mid- session.
- 5.15.18 If a tyre is damaged during a qualifying track session it may only be replaced with permission from the **Championship** Eligibility Scrutineer and who may in his absolute discretion for the purposes of this Regulation consult with the tyre manufacturer or manufacturer’s agent.
- 5.15.19 Tyres must have a tread depth of at least 2mm across the full width of the tyre prior to the start of any on track session.
- 5.15.20 The use of tyre heating equipment / heat retention devices tyre treatments or compounds is prohibited. Any artificial cooling of tyres is prohibited.
- 5.15.21 The Organisers reserve the right to amend the tyre allocation during the course of the season, which will be communicated to competitors by way of a Championship bulletin.
- 5.15.22 It is only permitted to inflate tyres with air of atmospheric composition no other medium may be used. The **Championship** Eligibility Scrutineer may request for the inflated tyres to be tested at any time to ensure that no medium other than air is being used.
- 5.15.23 Only in exceptional cases where in the judgement of the **Championship** Eligibility Scrutineer damage to a maximum of 2 (two) nominated tyres makes further participation in the event impossible nominated ‘used’ front and/or rear tyres may be substituted. A ‘used’ tyre is defined as a tyre that has been nominated at a previous **Event** and has been recorded as such by the **Championship** Eligibility Scrutineer. The substitution may only be authorised by the **Championship** Eligibility Scrutineer.
- 5.15.24 The only exception to this is the first race weekend of the year. If during the first race weekend of the year damage to a maximum of 2 (two) nominated tyres makes further participation in the event

impossible two new tyres may be substituted. The substitution may only be authorised by the [Championship Eligibility Scrutineer](#)

- 5.15.25 In very exceptional cases where in the judgement of the [Championship Eligibility Scrutineer](#) damage to tyres through no fault of the competitor makes further participation in the event impossible and all previously nominated tyres are not usable additional tyres above the total allocation for the season may be purchased. However, for every additional tyre purchased the competitor will incur a nine (9) Championship point deduction. It is the competitor's responsibility to notify the [Championship Eligibility Scrutineer](#) of their intention to exceed the tyre allocation prior to any Qualifying sessions or races.
- 5.15.26 It is not permitted to use any means to artificially raise the temperature of tyres above ambient at any time prior to or during any event other than by the natural addition of heat resulting from permitted driving on the circuit.
- 5.15.27 Tyre warmers or any other device intended to modify or maintain tyre temperature is forbidden. Tyre warmers found at the circuit will be judged to be available for use and appropriate action will be taken.
- 5.15.28 Tyres must only be used in the standard condition as supplied by the manufacturer. The application of any material (liquid solid or gas) to any part(s) of the tyre is therefore forbidden. The only exceptions are the use of a mixture of pure domestic water and household detergent, or the lubricant applied to the tyre bead for fitting purposes. The Championship Organisers reserve the right to take samples of tyre material at any time for laboratory analysis.
- 5.15.29 The application of any material (liquid solid or gas) to any part(s) of the tyres during official practice is forbidden.
- 5.15.30 It is permitted to remove debris / rubber pick-up from the tyre surface by the use of a tool and / or heat gun.
- 5.15.31 Any tyre protection covers used at any time within the confines of the circuit must be of a temporary construction and must be capable of being used many times.
- 5.15.32 Pressure regulation valves are forbidden.
- 5.15.33 Official Friday Test Days and Exclusive Test Days: Competitors will be limited to 1 new set (four tyres) of the championship nominated tyres for each of these days. Tyres must be nominated via the tyre nomination system no less than 30 minutes before the first session. The other tyres eligible to use on the official/exclusive test days will be tyres previously nominated for an earlier official/exclusive test days or tyres nominated for race weekends. Tyre nominations and use will be monitored. Failure to comply may result in the imposition of behavioural points and subsequent fines.

5.16 TYRE NOMINATION

- 5.16.1 Each competitor must record on the Tyre Nomination Form the serial numbers of the 6 dry tyres which they intend to use in the event.
- 5.16.2 The Form must be submitted online via [SRO Motorsport](#) nominated form to the [Championship Eligibility Scrutineer](#) before the first timed practice. The onus is on the competitor to ensure that the completed form is deposited with the [Championship Eligibility Scrutineer](#) and appointed representative before the first official timed practice. Failure to do so will be the subject of a report to the Clerk of the Course / Stewards.
- 5.16.3 During qualifying and races only, tyres nominated under **5.15.1** and wet weather (treaded) tyres may be kept in the pits.
- 5.16.4 During the event checks will be made by the [Championship Eligibility Scrutineer](#) or their appointed representative to ensure compliance between the tyres used and serial numbers recorded on the nomination form. At the end of the race all placed cars may be checked for compliance with this tyre regulation. Non-compliance at any time during the event will be the subject of a report to the Clerk of the Course/Stewards.

5.16.5 At the [Championship](#) Eligibility Scrutineer's discretion the 6 tyres for the event listed on the Tyre Nomination Form may be retained at the end of Official Qualifying and Race(s) until a minimum of 30 minutes prior to next time that the tyres are required to be used.

5.17 WEIGHT

5.17.1 The minimum vehicle weight including driver is 1395kg. The weight includes the driver suitably dressed for competition with safety helmet and all safety equipment. It is emphasised that the minimum weight must be respected at all times during both Qualifying and Competition.

5.17.2 Guest Competitors must run an additional 25kg above the minimum weights as described in **5.17.1** at their first round they compete. All rounds thereafter, guests can remove the additional 25kg weight.

5.17.3 In order to meet the criteria of **5.17.1** only it is permitted to add ballast to the car in accordance with **NCR Ch.7 App.2 Art.19**. Such ballast must be formed of solid unitary blocks. They must only be fixed using a ballast plate supplied by Ginetta Cars Ltd (G123R-0051NA.00) which is bolted to the floor of the passenger seat well in the designated area of the car. The ballast plate fixings must be able to withstand acceleration / deceleration forces of 25G.

5.17.4 The ballast tray studs which secure the ballast stack cannot protrude more than 10mm above the securing nut on top of the ballast stack. The studs must protrude by a minimum 1mm above the securing nut on top of the ballast stack.

5.17.5 Provision must be made for the [Championship](#) Eligibility Scrutineer to affix seals to any ballast fitted.

5.17.6 Following competition, the driver must remain available with the car under Parc Fermé conditions until released by the [Championship](#) Eligibility Scrutineer and / or Organisers in order to ensure weighing is completed with the minimum of delay. Drivers who are required for post-race prize giving and / or media interviews and who are directed from Parc Fermé by an official of the [event](#) or a [SRO Motorsport](#) official are permitted to leave Parc Fermé although must return to their car after such events have taken place to ensure weighing is completed.

5.17.7 If a car loses a part during qualifying or a race the weight of that part may be taken into account during eligibility checks. Following consultation, the [Championship](#) Eligibility Scrutineer will determine whether any lost part should be taken into account.

5.17.8 The Organisers reserve the right to amend the minimum weights. Any amendments will be made by official Championship bulletin.

5.18 FUEL, FUEL INJECTION AND FUEL

5.18.1 A standard fuel tank as supplied by Ginetta Cars Ltd must be retained in its original position. The fuel delivery system must remain as original specification.

5.18.2 The standard 80 litre fuel tank (G137M-0021NA.00) and fuel delivery system may only be substituted by alternative components that are approved and supplied by Ginetta Cars Ltd.

5.18.3 The use of a controlled unleaded fuel complying with the definition laid down in **NCR Ch.1 App.1 (Definition and Nomenclature)**, and supplied by Sunoco, is mandatory. Compliance with this regulation will be verified by fuel testing throughout the season.

5.18.4 The Championship official fuel supplier is mandatory. Compliance with this regulation will be verified by fuel testing throughout the season. Details of the official Championship fuel supplier will be provided at the start of the season by Championship Bulletin.

5.18.5 At the end of practice / qualifying and of the race at least 3 litres of fuel from the tank of the competing car must be available to the [Championship](#) Eligibility Scrutineer for analysis if required. Compliance with minimum weight for the car will be taken before fuel is removed as part of any eligibility check.

5.19 SILENCING

5.19.1 The exhaust system as supplied by Ginetta Cars Ltd must remain as standard and may not be altered. All cars must comply with **NCR Ch.7 App.8.** concerning noise levels and it is the competitor's responsibility to ensure that the car complies with currently enforced levels.

5.20 NUMBERS AND CHAMPIONSHIP DECALS

5.20.1 All cars must carry Championship and Championship trade sponsor decals as required by the Organisers from time to time.

5.20.2 Each car must carry Championship decals as per the figure in **Appendix A.** Competitors will be supplied with three number squares incorporating the major sponsors logos. One must be affixed to each side of the car in the position normally occupied by the doors. The third must be located to the front / top aspect of the car so as to be clearly visible. Competition numbers must be affixed to these squares and to the front / top aspect of the car so as to be clearly visible.

5.20.3 [SRO Motorsport](#) may request at any point that additional Championship / trade sponsor decals are carried on cars. This will be done by way of an official Championship bulletin. The Championship organisers reserve the right to remove from any competing car any decals or branding which is deemed to be unsuitable or conflicts with other Championship / [SRO Motorsport](#) sponsors.

5.20.4 Failure to comply with regulations **5.20.2** and **5.20.3** will not be subject to a technical non-compliance but will be liable to penalty under the Commercial Regulations for the Championship.

5.21 PRESENTATION

5.21.1 Having due regard to the best interests of the Championship Sponsors the Championship image [SRO Motorsport](#) and of safety competing cars are to be presented in a clean and mechanically and visually acceptable condition. Organisers reserve the right to insist that such standards of presentation are maintained as a condition of racing within the Protyre Motorsport Ginetta GT Championship. Individual cars may fail scrutineering if as deemed by the [Championship](#) Eligibility Scrutineer to be of poor presentation and / or mechanically unacceptable.

5.22 RACE SUITS

5.22.1 All competitors will be required to wear the official Ginetta branded race suit for all official qualifying and races, as per the diagram in **Appendix B.** The Ginetta logo may be displayed in either black, white or orange to fit with individual designs. The championship logos are to remain in the mandated location on all suits.

6. COMMERCIAL REGULATIONS

The following Commercial Regulations are contractual between the Entrant and / or Teams and / or Driver and the Organisers and / or Promoters and are not considered by the Motorsport UK. Accordingly, the application of these Commercial Regulations by the Organisers and / or Promoters will not be subject to the Judicial processes of either the Championship Stewards and / or the Motorsport UK / MSC. However, these Commercial Regulations are in the nature of a continuing binding contractual warranty and undertakings given by and on behalf of all Entrants Teams and Competitors in the Championship to the Organisers by the action of applying for and during any current period of Registration and accordingly they are enforceable as such.

Entrants Teams and Competitors acknowledge warrant and undertake with the Organisers that any Championship Registration under these Championship Regulations may be suspended withdrawn or revoked by the Organisers for any breach of these Championship Regulations including but not exclusively these Commercial Regulations. Such suspension withdrawal or revocation of Registration shall not serve in the nature of any liquidated damages or penalty for breach of the contract that is represented by the Championship Regulations and the Organisers are at liberty to seek such remedy and in such forum as they may in their absolute discretion deem appropriate.

6.1 COMMERCIAL UNDERTAKINGS

The [Events](#) comprising the Championship shall be conducted in accordance with the Regulations and these Commercial Regulations.

In these Commercial Regulations the nomenclature definitions and abbreviations specified in the **NCR** from time to time and in the Sporting Regulations of these Championship Regulations shall be adopted.

The Organisers acting through the Championship Coordinator have the right to amend vary or add to the Commercial Regulations from time to time. Such amendments variations and additions shall be notified by bulletin to all Registrants by posting to the address detailed on the Championship Registration Form or by sending to the e-mail address detailed on the Registration Form or faxing to the fax number detailed on the Registration Form (if any) or delivery to the competitor by hand.

All Competitors Entrants Teams and persons associated with them for the purposes of the Championship agree to be bound by the Commercial Regulations and any additions, variations or amendments thereto and Competitors Entrants and Teams to shall procure compliance by persons associated with them at all material times.

6.2 **TEAM COMMERCIAL AGREEMENT**

6.2.1 [SRO Motorsport](#) Team Franchise Details.

6.2.2 In order for teams to run cars in [SRO Motorsport](#), Ginetta Championships they will be required to sign up to a [SRO Motorsport](#) Team [Commercial Agreement](#). This will ensure that the customer proposition can be more consistent and allows teams to have a more confident future within the [SRO Motorsport](#) franchise because drivers will be required to run with those teams who have a [Team Commercial Agreement](#) with [SRO Motorsport](#).

6.3 PENALTIES

6.3.1 Warning: The terms of the Commercial Regulations are fundamental to the contract between SRO Motorsports Group and the Registrants. All Entrants Teams and Competitors acknowledge warrant and undertake with the Organisers that any breach of these Championship Regulations including any breach of any of the Commercial Regulations may render the Competitor and / or the Entrant and / or Team

ineligible for competition and in such circumstances continued participation in this Championship will be entirely at the discretion of the Organisers who may revoke or suspend or withdraw any Registration. The Organisers as an alternative and/or in addition to revoking or suspending or withdrawing the Registration of the Competitor and / or Entrant and / or the Team for participation in the Championship may but subject to the Organisers' absolute discretion refer the matter to the Championship Stewards in order that if those Stewards see fit they may impose any one or more of the following penalties as a condition of continued participation in the Championship but in respect of such matter there shall be no contractual right of Appeal to the MSC National Court:

- (a) Reprimand, which may include forfeiture of a qualifying time or times.
- (b) Time penalty.
- (c) Disqualification.
- (d) Forfeiture of Championship points (even if this results in a minus total of points).

6.3.2 In addition, or in lieu of any such penalty this Organisers acting through the Championship Coordinator may require the competitor and/or Team to take such steps as may be reasonable to mitigate the damage to the reputation of the Championship and / or the Organisers.

6.3.3 A breach of any of the Commercial Regulations may additionally or alternatively result in a fine as contractual liquidated damages up to a maximum of £1,000 for each offence being imposed by the Championship Co-ordinator. All such liquidated damages must and shall be paid forthwith as a debt to [SRO Motorsport](#) and Championship Registration will be suspended until such payment has been received, participation in the Championship by that Entrant/Driver will be entirely at the discretion of the Championship Co-ordinator.

6.3.4 In the case of an alleged breach of any Commercial Regulation the decision of the Organisers is final as to the culpability and penalty (and for the avoidance of doubt there is no appeal to the MSC National Court.

6.3.5 Where in the opinion of the Organisers any Competitor and / or Entrant and /or Team has gained an unfair advantage (whether inadvertently or not) from a breach of the Commercial Regulations by its own actions or those of another Competitor or Entrant or Team the Organisers acting through the Championship Coordinator may impose any one or more of the penalties set out in Commercial Regulation **6.3.1** above in order to remove or otherwise compensate for such advantage.

6.3.6 All cars must have a transponder fitted and working for any Friday practice session immediately prior to race weekends. Any competitor running without a transponder during an official test session will have championship points deducted. 5 championship points will be deducted for each test session that a driver fails to fit a working transponder.

6.3.7 It will be at the decision of the Organisers and / or Clerk of the Course as to whether or not a driver is penalised. Any evidence may be used to determine whether or not a working transponder has been fitted, including information / data from the official timekeepers.

6.4 TESTING

6.4.1 Testing in the Protyre Motorsport Ginetta GT Championship is unrestricted.

6.5 TELEVISION

- 6.5.1 By entering the Protyre Motorsport Ginetta GT Championship, competitors, entrants and Teams are obliged to assist SRO Motorsports Group, Hayfisher Productions and Ginetta Cars Ltd in the promotion of the Championship and in particular, the television coverage.
- 6.5.2 All competitors, entrants and Teams are obliged to assist the SRO Motorsports Group and Ginetta Cars nominated TV Production Company in the filming of Championship events and activities through the granting of interviews when requested and any other reasonable requests of the TV Production Company or the Coordinator.
- 6.5.3 Drivers finishing first, second and third in the Drivers' Championship must make themselves available immediately after each Qualifying session, Race and/or the prize giving ceremony for any media interviews in accordance with the requirements and directions of the Coordinator.
- 6.5.4 All cars must carry an in-car camera or on-board camera during testing, free practice, official qualifying sessions and/or the races at the request of the TV Production Company or the Coordinator, and all cars must carry a Championship on-board Judicial camera **(3.4)**.
- 6.5.5 Footage from any camera used by competitors or Teams cannot be used for commercial exploitation or public broadcast. Any footage produced in breach of this Regulation will forthwith upon request be delivered up to the Coordinator in addition to any penalty imposed.
- 6.5.6 Any competitor and/or anyone connected with a competitor is prohibited from trying to influence the editorial decisions of the TV Production Company in connection with the Championship as it is shown on television or of otherwise interfering with television coverage.
- 6.5.7 The decision as to which car is to carry an on-board camera and/or an in-car camera rests solely with the TV Production Company, Ginetta Cars and the Coordinator whose decision shall be final.
- 6.5.8 It is permitted to install own brackets in a competing car in order to incorporate an in-car camera but always subject to the prior approval of the Championship Scrutineer and the nominated TV Production Company.
- 6.5.9 The SRO Motorsports Group and Ginetta Cars nominated TV Production Company shall have unrestricted access to any video footage captured by the drivers and / or Teams or their associates and may incorporate any such material in its coverage of the Championship.
- 6.5.10 All footage obtained or recorded by the SRO Motorsports Group and Ginetta Cars Nominated TV Production Company of the Championship belongs to the SRO Motorsports Group and Ginetta Cars nominated TV Production Company and all competitors, entrants and Teams and their associates consent to their images being used by SRO Motorsports Group, Hayfisher Productions and Ginetta Cars (and those authorised by it) for promoting the Championship and merchandise associated with the Championship.

6.6 TEAM FILMING / FOOTAGE

- 6.6.1 Teams may only undertake their own 'behind the scenes' filming, providing written permission - clarifying what content you wish to film & where you intend to use it (i.e., Team website etc.) – is first be obtained from Kelly [Robertson](#), [SRO Motorsport](#) Championship Coordinator. [A licence fee is payable to SRO Motorsports for all approved accreditation.](#)
- 6.6.2 Accreditation, via the Team, must also be applied for from Tom Hornsby - tom.hornsby@sro-motorsports.com stating the intention of the person or crew to film video footage, not stills photography. All accreditation must be applied for directly with the circuits too.
- 6.6.3 If approved final accreditation for each event must be applied for by the filming Team, directly through each circuit. This includes the requirement to sign on with the circuit at each event.

They will issue you with a bib, which **MUST BE WORN WHEN FILMING** or the camera operator will be ejected from the circuit.

- 6.6.4 **ABSOLUTLEY NO FILMING IS ALLOWED IN THE PIT-LANE, THE GRID, PARC-FERME OR ASSEMBLY AREA. YOU ARE NOT PERMITTED TO FILM ANY PART OF THE RACES OR ANY MOVING RACE CARS - AT ANY TIME, OR FROM ANY LOCATION.**
- 6.6.5 Teams will be permitted to film in and around the garages, paddock areas, spectator and trade areas, transporters, hospitality & motor homes. Garage filming must only be from within the garage, not from the pit-lane looking in.
- 6.6.6 Film crews must remain cognisant of the TV crew, who have priority at all times.
- 6.6.7 Film crews may film the podium but only from behind the TV crew and not obscure or hinder TV's filming of the podium.
- 6.6.8 A positive image of [SRO Motorsport](#), Ginetta and its competitors, sponsors and officials must be portrayed at all times. [SRO Motorsport](#) reserve the right to immediately withdraw any permission granted, should they deem it preferable and/or necessary to do so.
- 6.6.9 Any filming or material obtained that goes outside these guidelines will result in the immediate withdrawal of any further permissions to the Team for the rest of the season.

6.7 ON-BOARD FOOTAGE

- 6.7.1 Teams may use short clips of footage (up to 2 minutes in total) taken from the Judicial Cameras in Free Practice 1 or 2, on the following terms.
- A complete lap cannot be shown - it must be interspersed with other angles or footage. No more than 30 seconds of continuous footage at any one time can be used.
 - Any on-board footage containing vision or sound of anything out of the ordinary, negative or untoward - particularly regarding another competitor - cannot be used (e.g., another car spinning off, or having an incident or mechanical failure etc).

6.8 ADVERTISING

- 6.8.1 No advertising of tobacco or tobacco products is permitted in any shape or form in this Championship. Additionally, any products that are not permitted to be advertised on UK television are also prohibited, along with any products that have an age restriction of above 16. The Organisers reserve the right to censor any advertising that may at the absolute discretion of the Championship Coordinator and / or the Organisers be deemed to be unsuitable. Any car or driver considered by the Championship Coordinator and / or the Organisers in their absolute discretion to be exhibiting unsuitable advertising may be disqualified from any Round of the Championship.

6.9 CHAMPIONSHIP LIVERY

- 6.9.1 Approved [SRO Motorsport](#) Championship stickers must be fixed to each competing car. Please see regulation **6.8** for further details.

All surfaces which have not been claimed for stickers by [SRO Motorsport](#) its sponsor companies or used for the application of starting numbers are free for use. Conflicting sponsor's stickers must be approved by the Championship Coordinator in advance and the position and size and colours (if approved) will be at the discretion of the Championship Coordinator.

- 6.9.2 All drivers must wear the approved branded [SRO Motorsport](#) Championship race suit which includes approved championship badges, unless permission has been granted from the Championship Coordinator to use an alternative. The championship Organisers reserve the right to remove any badges

or branding which is deemed to be unsuitable or conflicts with other championship / [SRO Motorsport](#) sponsors. **Appendix B.**

6.10 PUBLICITY

- 6.10.1 At all Championship [Events](#), Drivers, wearing their driving overalls, must take part in any autograph session, paddock walkabout and pre-race parade, when requested by the Championship Coordinator.
- 6.10.2 All drivers who qualify for an award shall attend the podium ceremony and any post-race televised interviews wearing their race winners' caps to be provided by [SRO Motorsport](#). Failure to attend the podium ceremony or failure to attend correctly attired may result in a fine being imposed by the Organisers.
- 6.10.3 In signing the Championship Registration Form, competitors, entrants and Teams agree that [SRO Motorsport](#) (and those authorised by it) may make use of their activities and successes in motor sport for any advertising, publicity, public relations and merchandising purposes. The competitors, entrants and Teams also agree that in any advertising or promotion with which they is associated (relating to the Championship), the full title of the Championship (including the Championship sponsors name) will be used at all times.

6.11 MERCHANDISING

- 6.11.1 The competitor, entrant and Team hereby authorise [SRO Motorsport](#) (and those authorised by it) to use and reuse and licence the use of images and representations of the vehicles competing in the Championship and the name, images and representations of the driver, the Team, the Team logo and Team paraphernalia including (insofar as the same appear on the clothing worn by the competitor or on Team paraphernalia or on the cars driven by the competitor in the Championship) the logo and decals of all sponsors of the competitor and/or entrant for the purposes of producing merchandise exploiting the reputation of the Championship and all elements of the Championship.
- 6.11.2 The competitor, entrant and Team authorise [SRO Motorsport](#) (and those authorised by it) to use and licence others to use all Championship images and other material relating to the Championship in marketing and packaging material and commercial advertisements exploiting the Championship or merchandise of the Championship or any individual elements of the Championship.
- 6.11.3 The competitor, entrant and Team shall assist [SRO Motorsport](#) and those authorised by it with the promotion of the Championship and production and promotion of merchandise associated with the Championship.

6.12 EVENT ARRANGEMENTS

- 6.12.1 Throughout the course of the Championship, the Coordinator may inspect all race transporters and motorhomes to ensure that they are of smart appearance and in good order. The Coordinator may refuse to issue a Paddock vehicle pass to any vehicle that they deems to be unsuitable for display within the Paddock.
- 6.12.2 At the start of each [Event](#), practice session and race, the competing cars and all Team vehicles must be clean, of smart appearance, and in good order. The Coordinator reserves the right to suspend competitors not meeting this requirement from taking further part in the Championship and withdraw passes until this Regulation is fulfilled to their satisfaction.
- 6.12.3 Any Team considered by the Coordinator, in their absolute discretion, to be exhibiting unsuitable advertising may be asked to withdraw it immediately.

6.13 SRO PASSES

6.13.1 Permanent passes will be issued to each registered Ginetta GT competitor for his/her sole use and these will be valid for every round of the Championship. Each competitor shall be given the following number of passes:

- 6 x Pit Lane / Paddock access passes
- 2 x Private car passes
- 1 x Transport pass

6.13.2 Please note that these passes are issued in accordance with Commercial Undertaking 6.10 with respect to Team transport.

6.13.3 SRO passes will be issued to each registered Entrant/Driver for their sole use and these will be valid for every round of the Championship. Entrants/Drivers shall make applications for passes by completing the Vehicle/Staff Information Form and returning it to the Championship Co-ordinator by 1st March. The Championship Co-ordinator will not process Vehicle/Staff Information Sheets unless they are fully complete. Submission of an incomplete form or late return of the form to the Championship Co-ordinator, may result in no passes being available for the first Event and the withholding of an Entrant's/Driver's entry.

6.13.4 SRO passes are issued on condition that the person or organisation to whom they are issued waives any and all claims it may have now or in the future and releases from all liabilities and agrees not to take any legal action and to always hold harmless, SRO Motorsports Group, BRSCC Ltd and their employees, agents and representatives and servants, the Motorsport UK, the Race Organisers, the Promoters, the Venue Owner, the Championship Coordinator, any participating Team and all employees, agents, servants and contractors thereof for any personal injury, death, damage or loss of any kind that the pass holder may sustain as a result of or in connection with the pass holder's presence within the venue. This indemnity does not apply insofar as injury or death is caused as a result of the negligence of the party seeking an indemnity.

6.13.5 Entrants/Drivers will be required to sign for receipt of their SRO passes. By accepting the issue of these passes, the Entrant/Driver is deemed to agree to abide by the pass conditions and to undertake the obligation to advise each person to whom they are issued of the pass conditions and to ensure the observance thereof.

6.13.6 SRO passes are issued subject to the following conditions:

- A SRO pass may only be used to gain access to the areas indicated on the face of the pass. Any person found within a restricted area without the appropriate pass may be removed from the venue immediately and/or have any pass held by them withdrawn.
- A SRO pass may only be used by the Entrant/Driver to whom it is specifically issued. It is forbidden to alter or deface passes in any way or to allow a pass to be used to authorise the entry of more than one person at each Event.
- SRO passes must be worn around the neck of the person to whom it is issued so as to remain clearly visible at all times. It is forbidden to combine with or enclose a SRO pass within a wallet or holder of any kind (unless supplied by SRO or the Championship Organisers) or to attach additional items of any kind to it.
- SRO reserves the right to request further proof of identity in addition to a SRO pass.
- SRO at all times reserves the right to refuse admission to the venue or access to a designated area to any person, notwithstanding that such person may have been issued with an appropriate SRO pass.
- Entrants/drivers will be required to sign for the receipt of their SRO passes.

- 6.13.7 SRO , in conjunction with the Championship Coordinator, reserves the right to remove immediately from the venue any person who is found to have violated the pass conditions contained in these Commercial Undertakings and/or to withdraw permanently a SRO pass issued to such person and/or to take or institute legal proceedings against that person.
- 6.13.8 All registered Entrants/Drivers are fully liable for any personnel and vehicle passes issued to them by SRO and/or received on the Entrant's/Driver's behalf. The misuse of any passes allocated to an Entrant/Driver will result (without prejudice to any other action which may be taken by SRO under the terms of these Commercial Undertakings) in SRO imposing a fine of £1,000 for each act of misuse of the pass together with the confiscation of the pass concerned for such period of time as the Coordinator shall deem appropriate.
- 6.13.9 If a Championship Registration is withdrawn/forfeited, all passes issued in connection with that Registration must be returned to the Championship Coordinator. Any lost/mislaid passes will be subject to a penalty of £25.00 per pass multiplied by the number of remaining rounds.
- 6.13.10 SRO passes will not be replaced if they are lost/mislaid unless they have been stolen and a copy of the police report relating to that offence is submitted to the Championship Coordinator.
- 6.13.11 Each Entrant/Driver must also attend this [SRO Motorsport](#) Media Day with their intended Paddock vehicle for the season and erect their awning (if applicable) for measurement by the Paddock Team. Passes will not be issued until the plot size has been measured and agreed.

6.14 PADDOCK REGULATIONS

- 6.14.1 The amount of space requested will not necessarily be the space granted to an Entrant who will assess individual requirements at the [SRO Motorsport](#) Media Day.
- 6.14.2 Each Team will be permitted one transporter and awning to be parked in their designated Paddock area. Any Entrant requiring an additional awning must make a request in writing to the Championship Coordinator prior to the first Event. Only Entrants running more than four cars will be permitted an additional awning. Entrants running three or more cars may be permitted additional space for a Support Vehicle/flat patch. Awnings are not permitted on Support Vehicles.
- 6.14.3 Each Entrants / Drivers are required to have one fire extinguisher per car (maximum capacity 5kg or it's equivalent) within their transporter/awning at each Event. This shall not include the extinguisher fitted to the car(s).
- 6.14.4 Any amendment to the vehicle and/or awning size required must be notified in writing to the Championship Coordinator for their approval prior to use.
- 6.14.5 The space allocated by SRO Motorsports Group is granted for the preparation of race cars and Team catering. It is expressly forbidden to use this space as a hospitality area or trade site area.
- 6.14.6 Motorhomes/caravans and private cars are not permitted within the Paddock at any venue unless in exceptional circumstances and with the prior written approval of the Championship Coordinator.
- 6.14.7 No hospitality/entertaining will be allowed by Entrants/Drivers within the Paddock. Teams may use an area at the rear of their awning specifically for Team catering only.
- 6.14.8 Any small two or four-wheeled motorised Paddock vehicles which are authorised by SRO Motorsports Group or the venue may be used within the Paddock. These vehicles may only be used during authorised times and four-wheeled motorised Paddock vehicles can only be driven by a current full road traffic licence holder for race Team related business. Recreational use is strictly prohibited. Please note that private cars and vans are not considered as Paddock vehicles.

- 6.14.9 There is a speed limit of 10mph in the Paddock at each venue. The only movement of race cars permitted in the Paddock is on the way to the Assembly Area and on the way back from Parc Fermé with a current full road traffic licence holder seated in the Driver's position and in control of the car.
- 6.14.10 Tailgates on transporters must remain closed at all times except when loading and/or unloading your race cars.
- 6.14.11 Entrants/Drivers will be issued with a specific time to park up their race transporters in the Paddock at each Event. Access to the Paddock outside your parking-up time is forbidden, unless the express written permission of your Championship Coordinator has been obtained to park up at a different time. Verbal permission from circuit employees will not be accepted.
- 6.14.12 Any pipes, wires or cables trailing from motorhomes and/or transporters and/or generators must be protected by hard covers where they will be crossed by vehicles or pedestrians. All health and safety requirements must be met at all times and warning signs must be erected where there is any danger to the public or other persons.
- 6.14.13 All health and safety regulations as well as any such directives issued by the Championship and/or the venue must be met at all times.
- 6.14.14 It is an offence for any person to ride or drive any motor vehicle on the roads or other public areas under the control of the venue promoters unless they are covered by third party insurance. It is a condition of Registration that such insurance is in place. A copy of the policy must be lodged with the Championship Coordinator before the first Event of the season.
- 6.14.15 A fine of a minimum of £500 may be levied for any infringement of Paddock Regulations contained in these Commercial Undertakings at the absolute discretion of the and/or the Championship Coordinator. Each registered Entrant/Driver is responsible for the payment of fines incurred by all vehicles entering the Paddock/Pits on their behalf. The decision of the Championship Coordinator in respect of this additional penalty shall be final with no appeal to the MSC National Court.
- 6.14.16 No tail lifts are to be lowered until the cars for the last support race of the weekend has gone to the assembly area. Failure to adhere to this will result in a £500 fine.
- 6.14.17 All golf buggies or pit vehicles are to be parked either alongside or behind awnings or within the confines of your allocated space in the paddock. No golf buggies or pit vehicles are to be parked in the roadway.
- 6.14.18 All Paddock vehicles that require personnel to be on the roof (i.e., to affix awnings or flag poles/flags) must have the relevant safety equipment fitted. Any personnel on the roof must wear the relevant safety harnesses which must be affixed to the equipment on the roof, a £500 fine can be incurred if not adhered to. Please note that there will be regular H&S checks during the course of the season.
- 6.14.19 Teams should refrain from using 'single use plastics' within the paddock area, their garages or awnings, or hospitality areas. In this respect 'single-use' is a term which can refer to any plastic item either designed to be used for one time, or likely to be used in that way, within the venue. Such items include disposable single-use plastic bottles of water or drinks, plastic cups, plastic cutlery, plastic straws, thin plastic carrier bags, plastic drink stirrers etc.

A team which has no practical alternative to the use of a fully recyclable single use plastic item due to an existing commercial partnership, must first submit for approval a comprehensive plan for the collection within the venue and the recycling of those items including providing evidence as to the completion of their recycling after each event.

6.15 TIMETABLE REGULATIONS

- 6.15.1 SRO Motorsports Group (and those authorised by it) reserves the right to amend the race day timetable at its discretion.
- 6.15.2 Entrants/Drivers should listen carefully to the Paddock tannoy announcements and their Championship Coordinator regarding the time they are required in the Assembly Area. In ideal conditions the timetable may be brought forward and Entrants/Drivers may be called to the Assembly Area earlier than originally scheduled. Entrants/Drivers are warned that they will miss their qualifying session or race if they are not ready in the Assembly Area when the cars are released.

6.16 MISCELLANEOUS

- 6.16.1 Competitors, entrants, Teams and officials may not either individually or with any such participants or through any representative or agent, procure, solicit or arrange for any supplies, gratuities, products, merchandise, equipment or any other thing of value to be provided from any source whatsoever bearing or depicting any Championship logo and/or any trademark and/or any copyright and/or any image used or associated with the Championship without the prior written permission of the Coordinator to do so.
- 6.16.2 All images, photographs, recordings or representations of the participation in the Championship or association with the Championship of competitors, entrants and Teams may only be used for commercial purposes with the prior written consent of the Coordinator. No consent is required for normal media reporting of the Championship.
- 6.16.3 All the broadcast, recording, cable, satellite, digital, video, internet and interactive rights and other rights in all media to the Championship and other related events are the sole property of SRO Motorsports Group and Hayfisher Productions. Any recording or broadcast of the Championship and other related events or, rebroadcast or reproduction of material without express written permission of the Coordinator is strictly prohibited. competitors, entrants and Teams currently registered in the Championship may, subject to the prior written permission of the Coordinator and subject to any conditions that he may impose at their absolute discretion, be granted rights to use broadcast material for their own specific promotional use within the UK without fee or charge. Rights requested for any other commercial use must be made in writing to the Coordinator and if granted will be subject to Licence which may include a fee or charge.

6.17 RACE ORGANISING CLUBS & CONTACTS

Vehicle Manufacturer

Ginetta Cars Ltd
Helios 47
Garforth
Leeds
Tel: 0845 210 5050
E mail: enquiries@ginetta.com
Website: www.ginetta.com

Eligibility Scrutineer:

[Keith Auld](#)
Email: keith.auld1@outlook.com

Championship Organiser

British Racing & Sports Car Club
Unit 25 Wheatley Business Centre
Wheatley, Oxford, OX33 1XW
Tel: 01732 780 100
E-mail: enquiries@brscc.co.uk

Championship Coordinator

Kelly [Robertson](#)
Tel: 07917 261 345
Email: kelly.robertson@ext.sro-motorsports.com

Ginetta Parts Department

Tel: 0113 385 4164
Email: parts@ginetta.com

Control Fuel Supplier

[Sunoco Race Fuels PO Box 1226](#)
[Linwood, PA 19061](#)

Control Fuel Distributor

[AAOIL58 Holton Road Holton Poole](#)
[BH16 6LE](#) Tel: [01929 555974](tel:01929555974)

Paddock Layout Team

MSO
Derek Weller
Tel: 01162 593808
Email: Derek@m-s-o.co.uk

Governing Body

Motorsport UK
Bicester Motion
OX27 8FY
Tel: 01753 765000

Tyre Distributor

Protyre Motorsport
Tel: 01782 411001
Email: sales@protyremotorsport.co.uk

7 2026 SUPPORT SERIES ENVIRONMENTAL GUIDELINES 2026 CIRCUIT GREEN CHARTER GUIDELINES

The following guidelines address the topics of the Series' carbon emissions, water and waste management and recommend best practice procedures to be put in place by the participating Series, in order to improve the event's environmental footprint. Following the listed guidelines will contribute towards more sustainable operations, which will benefit the overall environmental performance of the Series as well. The guidelines were compiled in accordance with current environmental policies for carbon reduction and carbon footprint improvement.

7.1 CARBON EMISSIONS

Carbon reporting: Series to provide SRO with all required data sets for accurate measure of footprint, when requested, including details of;

All employee travel related to the event (number of employees, distances travelled and modes of transport used);

- Relevant logistics operations run in preparation for the race event (quantity of fuel consumed, total freight moved (kg) and modes of transport used);
- Any events emissions (all forms of fuel consumed at events for scooters, series operated cars, generators and equivalents);
- Total distance driven by series operated scooters, cars, trucks and machinery at event;
- Total electricity consumed at facilities away from tracks;

Carbon neutrality: Series to create a carbon reduction plan and management strategy for their carbon emissions where possible for race weekends, including generators use, mains electricity use and event vehicles (if not already in place).

Facilities electricity: Series to commit to using 100% renewable electricity by 2026 at the latest, and create a transition road map for how this will be achieved (at facilities away from track).

Event vehicles: Series to create and implement a plan to minimize the use of fossil fuel powered vehicles through a reduction in kilometres driven at events and switching to lower/zero carbon options (e.g. e-vehicles).

Scooters: Series to minimize the use of fossil fuel powered scooters, if any, across paddock transportation, either through replacement with e-scooters, or reduction in use of traditional scooters.

Generator use: Series to create a road map for full replacement of all ICE generators with lower/zero carbon alternatives by 2026 at the latest.

Series to eradicate use of space heaters if currently used.

Lower carbon diets: Series to offer at least one vegetarian and one vegan meal option to guests within the series' hospitality sites.

Logistics: Series to transition all logistics trucks to be at least Euro6 standard to limit carbon and air quality impacts from logistics.

Employee travel: Series to introduce employee travel carbon reduction plans, which should include:

- Limiting/ reducing the number of employees taken to each race where possible;
- Prioritizing lower carbon forms of travel such as train travel or car travel rather than flying;
- Increasing the hire of EVs/ Hybrids for transportation where possible;
- Carbon compensation for all flights in cases where flying is unavoidable;

7.2 WATER

Water consumption:

Avoid excessive washing of trucks in the paddock area, to reduce total paddock water consumption;

Fix and prevent all possible leaks during race weekends;

Clean discharge: Series to work with circuits to ensure all waste water discharged is done so in a safe manner, and does not cause any contamination of water causes or the local environment.

Chemicals: Series to work with circuits to ensure all chemicals used are safely discharged in the appropriate manners.

7.3 WASTE

Waste management and recycling: Series to ensure all waste created is correctly separated and fed into circuits existing recycling infrastructure;

Series to create a waste minimization plan to reduce total quantity of waste generated at race weekends;

Series to ensure all participating teams follow waste management and recycling practices;

Single use plastic: Series to eliminate the use of single use plastic across their paddock by switching to reusable alternatives for all existing single-use plastic;

Series to communicate that they are single-use plastic free through communication channels;

Food waste: Series to correctly separate all food waste and other compostable materials generated, and work with circuits to ensure it can be centrally collected for composting or similar (dependent on circuits infrastructure).

Tyre collection: Series to work closely with tyre partner to facilitate the collection and recycling of 100% of tyres used at race weekends.

APPENDIX A: Protyre Motorsport Ginetta GT Championship Decal Layout

GT CHAMPIONSHIP
AM

WINDSCREEN BANNER - PROTYRE



FRONT + REAR CORNERS



SILL STICKERS - BRSCC/PROTYRE



NUMBER BOARD-BONNET & BOTH SIDES



WINDSCREEN NUMBER - **FLURO YELLOW**

WINDSCREEN FRONT & REAR STRIP - **FLURO YELLOW**

MIDDLE REAR STICKER - **GTP8**

GINETTA
DECAL DETAILS

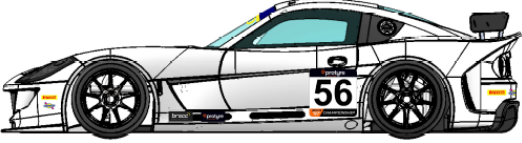
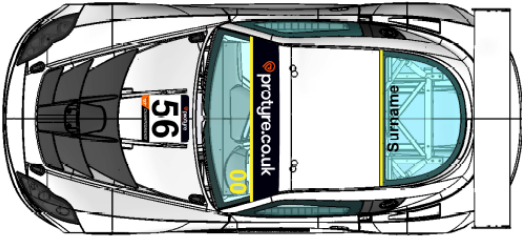
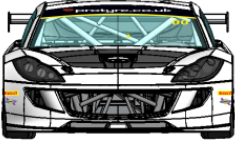
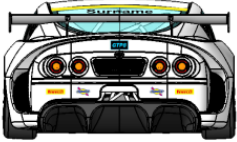





GT CHAMPIONSHIP
PRO

WINDSCREEN BANNER - PROTYRE



FRONT + REAR CORNERS



SILL STICKERS - BRSCC/PROTYRE



NUMBER BOARD-BONNET & BOTH SIDES



WINDSCREEN NUMBER - **FLURO ORANGE**

WINDSCREEN FRONT & REAR STRIP - **FLURO ORANGE**

MIDDLE REAR STICKER - **GTP8**

GINETTA
DECAL DETAILS

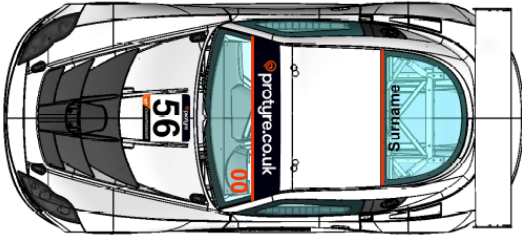
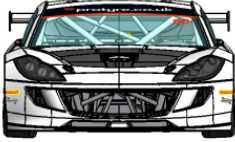
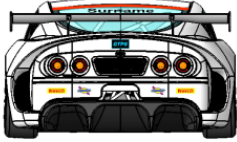
APPENDIX B: Protyre Motorsport Ginetta GT Championship Race Suit Logo Placement





A socially-minded standard of behaviour is expected from everyone within the motorsport community.

By participating in a Motorsport UK event in any capacity you agree to follow the values of the Respect Code:

Motorsportuk.org/racewithrespect
#RaceWithRespect

The Values

- Respect
- Integrity
- Self-Control
- Fair play
- Good Manners

I pledge to #RaceWithRespect and:

- Contribute to a welcoming and friendly environment that ensures the safety and welfare of all participants.
- Always behave with integrity and uphold fairness in the sport; play my part in keeping the sport safe through your actions
- Treat everyone with respect, regardless of their gender, ethnic or social background, language, religious or other beliefs, disability, sexual identity or other status
- Recognise that we all represent the sport and therefore have a duty to be polite and respectful to all staff, officials, fellow competitors, volunteers, as well as fans and supporters
- Respect the rules, regulations and authority of the officials and Motorsport UK

Any breach of these obligations may result in disciplinary action.